

AIRPAX®

IAL/CEL/LEL Series Magnetic Circuit Protectors



- Introduction* • 147
- Poles* • 148
- Handles* • 150
- Configurations* • 154
- Operating Characteristics* • 157
- Delay Curves* • 159
- Specifications* • 163
- Decision Tables* • 165



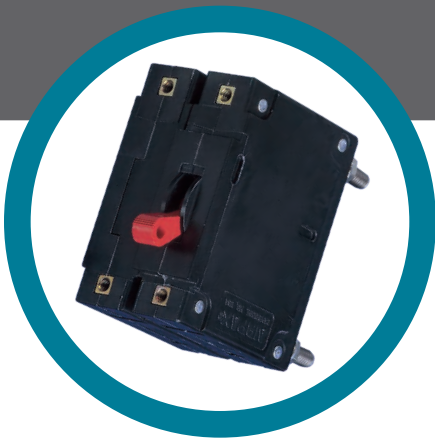

AIRPAX® | IAL/CEL/LEL Series Hydraulic Magnetic Circuit Protectors

INTRODUCTION

IAL/IUL/IEL/LEL magnetic circuit protectors provide low-cost power switching, reliable circuit protection and accurate circuit control for equipment in the international marketplace.

IAL models are for those applications where the unit's inherent attributes are desired, but compliance with the various standards is not required.

IUL models have been tested and approved in accordance with UL 1077 requirements for UL recognition.

IEL/LEL models are VDE approved to VDE 0660, part 101. They meet IEC spacing requirements, mandatory for equipment which must comply with IEC specifications 601 and 950, and VDE specifications 0804 and 0805. In addition, the IEL models are UL recognized to UL 1077 as supplementary protectors and

the LEL models are UL listed under the conditions of UL 489. Both are CSA certified and CCC Approved. The IEL is CSA certified as a supplementary protector per CSA C22.2–No. 235.

The CEL model has achieved two new enhancements, including a single pole, 125 amp rating with TÜV approval, and a parallel 4-pole version with 400 amp rating.

Airpax™ IAL/CEL/LEL circuit protectors are available in a wide variety of configurations, including series, series with auxiliary switch, shunt and relay with choice of delays and ratings in DC and/or 50/60Hz or 400Hz versions. Single or multi-pole versions are available with a variety of pole arrangements to meet your specifications. Please see the appropriate product specification table for ratings and limitations.

SINGLE POLE, STANDARD STUD TERMINAL

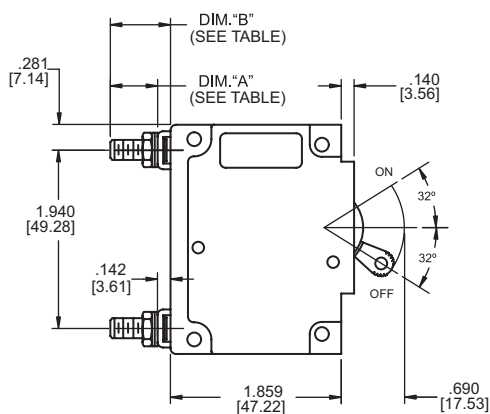

| STUD TERMINAL TYPES | | |
|---------------------|-------------------------------|-------------------------------|
| Screw Stud Thread | Dimension "A" | Dimension "B" |
| M6 | .510 ± .045 [12.95 ± 1.14] | .652 ± .035 [16.56 ± 0.89] |
| 1/4 -20 | .545 ± .045 [13.84 ± 1.14] | .687 ± .035 [17.45 ± 0.89] |
| M5 | .510 ± .045 [12.95 ± 1.14] | .652 ± .035 [16.56 ± 0.89] |
| 10-32 | .545 ± .045 [13.84 ± 1.14] | .687 ± .035 [17.45 ± 0.89] |

Single Pole

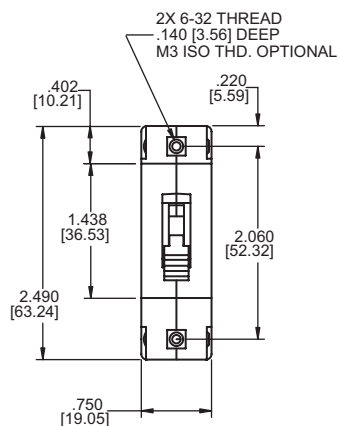

Mounting Detail

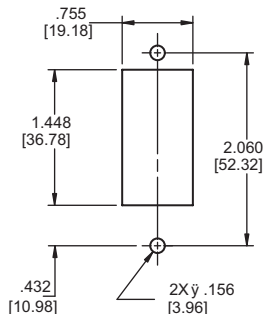

Panel Mounting Detail
Tolerance ±.005 [.13] unless noted.

Screw Terminal

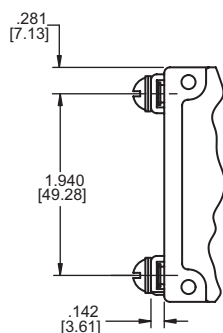

Clip Terminal

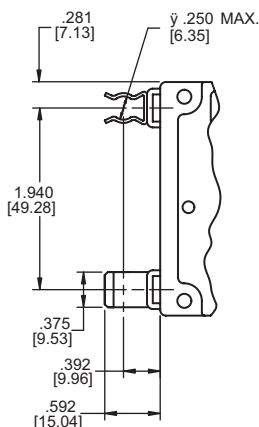

Bullet Terminal

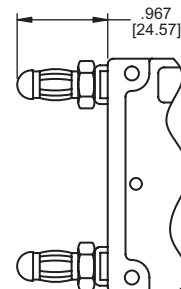

Notes:

Tolerance ± .015 [.39] unless noted.

Dimensions in brackets [] are millimeters.

A Terminal protrusion dimensions are referenced from back of mounting panel.

B Each screw terminal is supplied with a 10-32x.312 [7.92] or M5 x 8mm screw, flatwasher and external tooth lockwasher.

C Stud terminals are supplied with a flatwasher, external tooth lockwasher and a 10-32 or M5 hex nut (<=70A) (<=50A for LEL), 1/4-20 or M6 hex nut (>70A) (>50A for LEL).

Bullet terminal receptacle should be .312 ± .001 diameter hole not less than .250 depth. Contact Sensata for other bullet sizes.

Note: Each outer terminal is supplied with a flatwasher, tooth lockwasher and a hex nut.

MULTI-POLE CIRCUIT PROTECTORS

Multi-pole units are combined in an assembly with the trip mechanisms internally coupled. A fault in any protected circuit opens all poles simultaneously. Applications include use in polyphase circuits, single-phase three-wire systems, or in two or more related but electrically isolated circuits. A mix of delays, ratings and configurations are offered. The auxiliary switch is offered with either gold or silver contacts and is available when a series construction pole is specified.

Two Pole Units

An assembly consisting of two single pole units, having their trip mechanisms internally coupled, is available with either a single toggle handle or with a handle per pole. Please see decision one of the part number decision tables. Individual poles may vary in ratings, delays and internal configurations. If the poles are of series construction, an auxiliary switch may be included in either or both poles, allowing you to mix SELV and hazardous voltages.

Two Pole

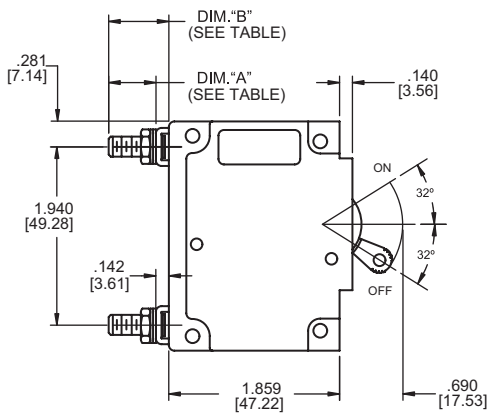

IELH11

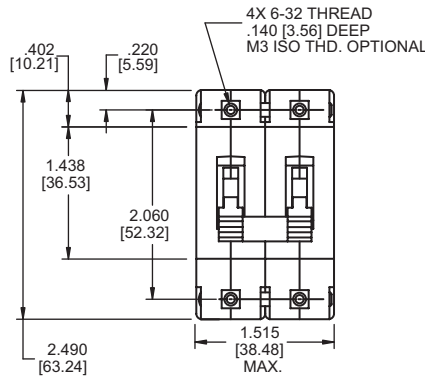

IEL11

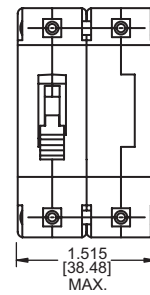

Note:
Tolerance $\pm .015$ [.38] unless noted.
Dimensions in brackets [] are millimeters.

| | | |
|-------------------|---------------------------------|---------------------------------|
| M6 | .510 | .652 |
| 1/4 - 20 | .545 | .687 |
| M5 | .510 | .652 |
| 10 - 32 | .545 | .687 |
| Screw stud thread | Dim. iA $\hat{}$ ($\pm .045$) | Dim. iB $\hat{}$ ($\pm .035$) |

Note:
Each outer terminal is supplied with a flatwasher, tooth lockwasher and a hex nut.

Two Pole*

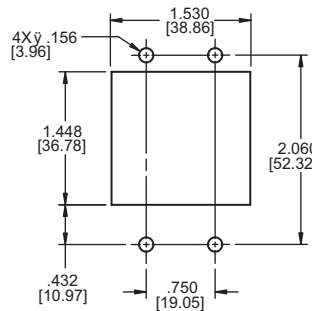

Two Pole*

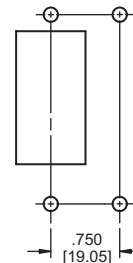

Panel Mounting Detail
Tolerance $\pm .005$ [.13] unless noted.

Note:
A Terminal protrusion dimensions are referenced from back of mounting panel.
B Each screw terminal is supplied with a 10-32x.312 [7.92] or M5 x 8mm screw, flatwasher and external tooth lockwasher.
C Stud terminals are supplied with a flatwasher, external tooth lockwasher and a 10-32 or M5 hex nut ($\leq 70A$), 1/4 -20 or M6 hex nut ($>70A$).

Three Pole and Four Pole Units

The three pole structure consists of three single pole units assembled with an internal mechanical interlock which actuates all units simultaneously. The units are available with either a single toggle handle or with a handle per pole. Units with four pole construction operate with a minimum of two center toggle handles or with a handle per pole. Please see decision one of the part number decision tables. Mixing of delays, ratings and configurations is available in each individual pole. The auxiliary switch is offered in any series trip pole.

Breaker poles are numbered consecutively when viewed from the terminal side, with the ON position up, starting with pole #1 on the left side and proceeding to the right.

Three Pole IEL111

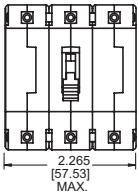

Mounting Detail*

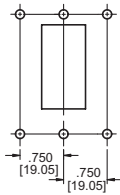

Three Pole IELH111

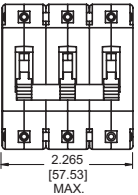

Mounting Detail*

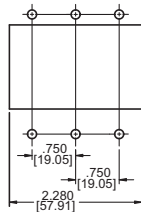

Four Pole IEL111

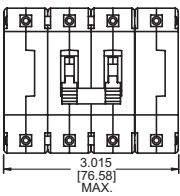

Mounting Detail*

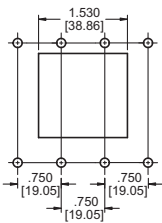

Four Pole IELH111

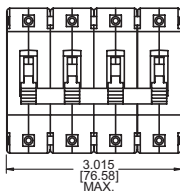

Mounting Detail*

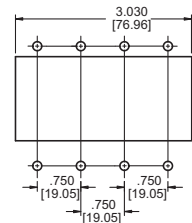

Panel Mounting Detail
Tolerance $\pm .005$ [.13] unless noted.

BX - FLAT ROCKER HANDLE

The innovative new design of our IAL/CEL/LEL BX Style circuit protectors features a flat rocker that will satisfy your aesthetic needs while guarding against accidental actuation, providing the highest degree of circuit protection and quality. Only Airpax offers this new standard in user interface. Available on a variety of versions with a full range of agency approvals, the IEL BX style circuit protectors meet or exceed all current performance specifications, including interrupting capacities up to 50,000 amperes.

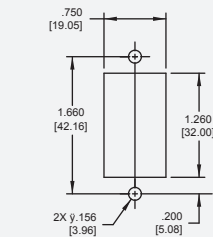
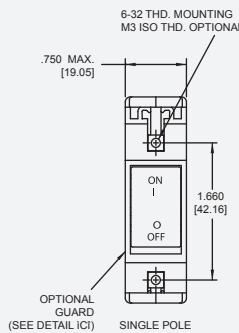
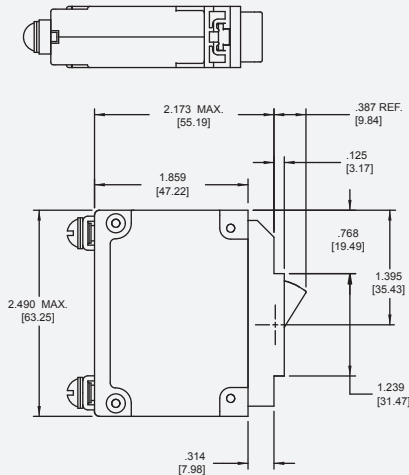

Panel Mounting Detail
Mounting Detail Tolerance: $\pm .005$ [.13] unless noted

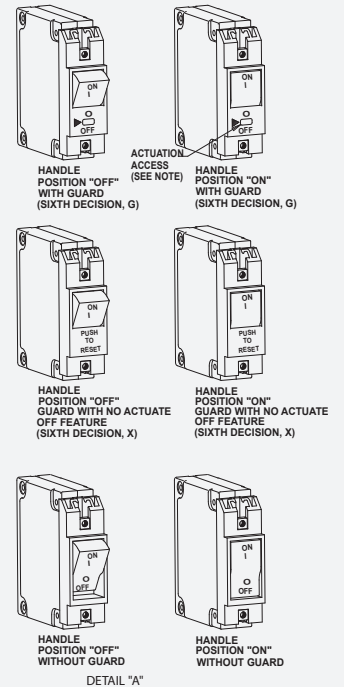

NOTE: ACCESS IS LIMITED TO A DEVICE SMALLER THAN THE UNDERWRITERS LABORATORY "ARTICULATED PROBE" DEFINED IN UL-489 FIG. 11.1.7.2.1.

Note:
Tolerance $\pm .015$ [.39] unless noted. Dimensions in brackets [] are millimeters.
*See Single Pole Mounting Detail for Hole Sizes and Locations.

LELHP/CELHP CIRCUIT PROTECTORS

The Airpax™ LELHP/CELHP high current magnetic circuit protector compliments our entire series of LEL circuit protectors. Its unique, parallel current sensing design provides precise current overload protection and reliability in the compact size of a two pole LEL. The unit is ideal for high power DC applications such as drive motor systems and telecommunication power systems.

LEL is available in series and series with auxiliary switch configurations with a choice of delays for DC ratings of 125, 150, 175 and 200 amperes. The CEL has been enhanced to include these same ratings plus a 4-pole, parallel 400 amp rating for UL489A. The LELHP is UL listed under the conditions of UL489 and CSA certified. The CELHP is UL listed under the conditions of UL489A. Mid-trip handle indication, voltage trip and remote operator options complete the LELHP/CELHP circuit breaker series. Please see the individual product tables for approved ratings.

Two Pole

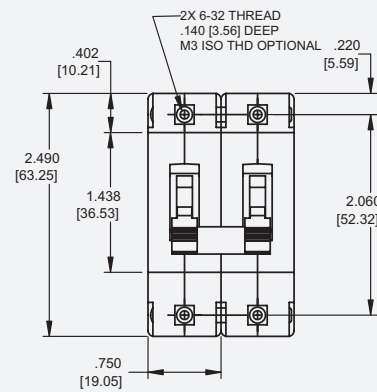
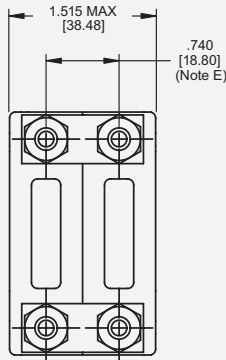
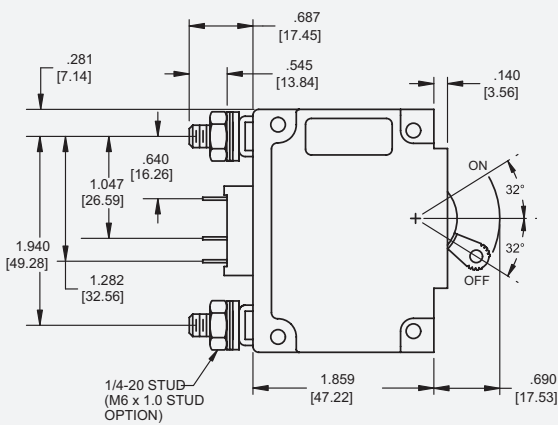

Three Pole (Note D)

Series Parallel



Series Parallel with optional 1REC4 Auxiliary switch

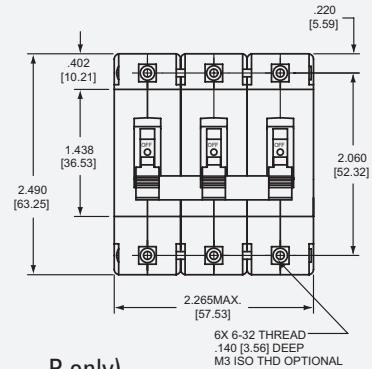
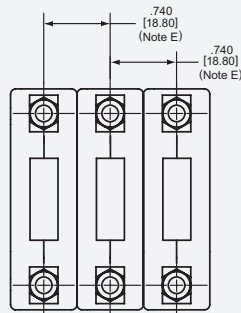
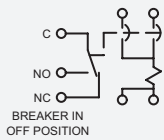

-REC4

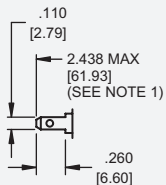

175/200 Parallel Pole

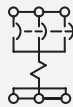

Four Pole (CEL __ P and CML __ P only)

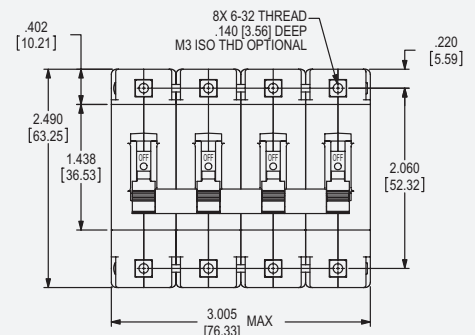
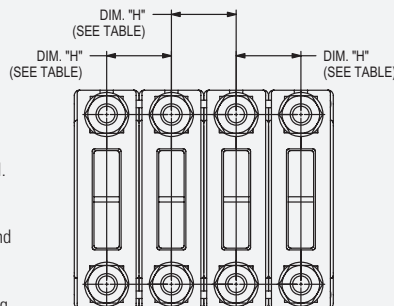

Notes:

- Tolerance $\pm .015$ [.39] unless noted. Dimensions in brackets [] are millimeters.
- A Terminal protrusion dimensions are referenced from back of mounting panel.
- B Each screw terminal is supplied with a 10-32x.312[7.92] or M5 x 8mm screw, flatwasher and external tooth lockwasher.
- C Stud terminals are supplied with a flatwasher, external tooth lockwasher and a 10-32 or M5 hex nut ($\leq 70A$), 1/4 -20 or M6 hex nut ($>70A$).
- D Units are supplied without bus bars must have a minimum copper strap (1 31/32 x 1/2 x 1/16) of appropriate length to accommodate connections tying each set of terminals together.
- E Other spacing available upon request. Contact factory for assistance.

IALN/IULN PANEL SEAL CIRCUIT PROTECTORS

The IALN/IULN family is a sealed toggle version of the IAL/IUL family. The silicone rubber seal around the handle assures panel seal integrity and makes this style a natural for harsh environments.

This sealed toggle family is available in one to three pole models with ratings of .050 to 100 amperes.

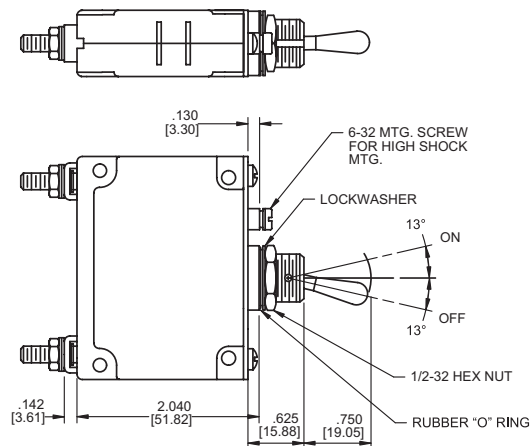

Single Pole

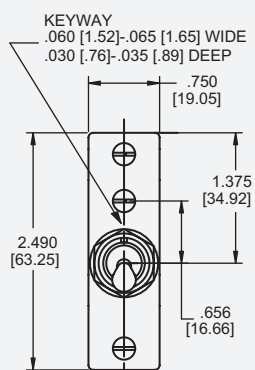

Two Pole

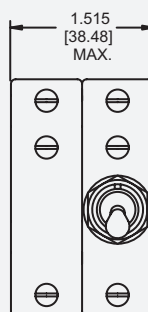

Three Pole

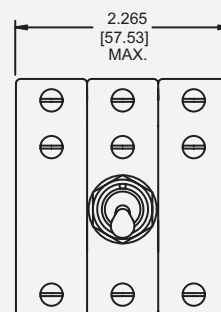

(Optional handle may be in pole 2 instead of pole 1.)

Panel Mounting Details: Tolerance $\pm .005$ [.13] Unless noted.

Single Pole

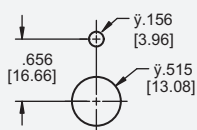

Two Pole*

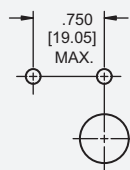

Three Pole*

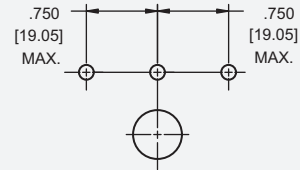

Optional handle

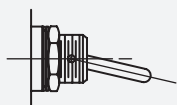

*See Single Pole Mounting Detail for Hole Sizes and Locations.

Notes:

- Terminal protrusion dimensions are referenced from back of mounting panel.
- Each screw terminal is supplied with a 10-32x.312[7.92] or M5 x 8mm screw, flatwasher and external tooth lockwasher.
- Stud terminals are supplied with a flatwasher, external tooth lockwasher and a 10-32 or M5 hex nut ($\leq 70A$), 1/4 -20 or M6 hex nut ($>70A$).

IALX/IULX/IELX ROCKER HANDLE

The rocker style is available in one to four poles. Choose either vertical or horizontal mounting with ON-OFF, international markings or a combination of both.

Five front panel enhancing colors including black, white, red, grey and orange are available.

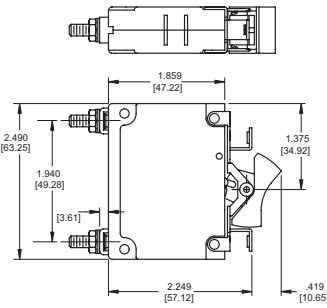

Single Pole

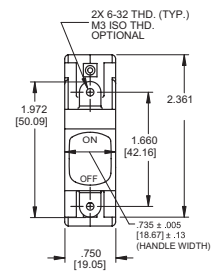

Two Pole

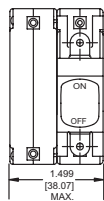

Three Pole

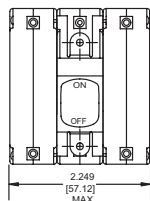

Four Pole

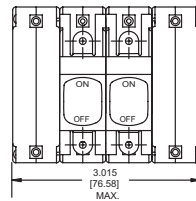

Panel Mounting Detail* Single, Two & Three Pole

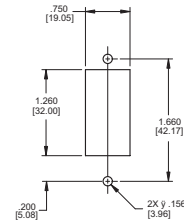

Four Pole**

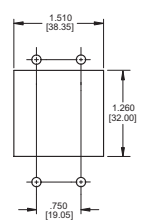

(Optional handle may be in Pole 2 instead of Pole 1.)

Note:

- A Terminal protrusion dimensions are referenced from back of mounting panel.
- B Each screw terminal is supplied with a 10-32x.312[7.92] or M5 x 8mm screw, flatwasher and external tooth lockwasher.
- C Stud terminals are supplied with a flatwasher, external tooth lock washer and a 10-32 or M5 hex nut (<=70A), ° -20 or M6 hex nut (>70A).

*Mounting detail tolerance $\pm .005$ [.13] Unless noted.

**See single mounting detail for hole sizes and locations.

IALZX/IULZX/IELZX ROCKER HANDLE

The IALZX/IULZX/IELZX style adds our rocker handle options of contrasting dual color rocker actuators, affording a clear visual indication of the handle position and integrated handle guards, to

help prevent accidental turn-on and turn-off of the unit. Available with a black rocker and white, red or green indicator color for either ON or OFF indication.

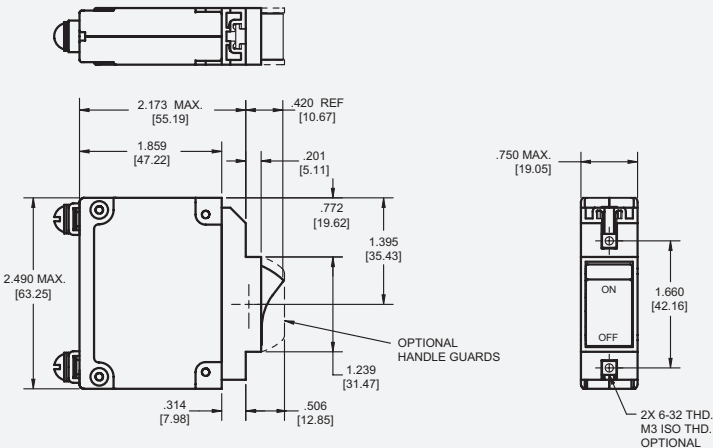

Panel Mounting Detail

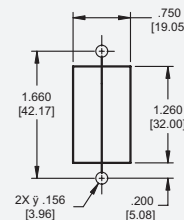

Note: Tolerance $\pm .015$ [.38] unless noted.
Dimensions in brackets [] are millimeters.

Panel Mounting Detail
Tolerance $\pm .005$ [.13] unless noted.

CONFIGURATIONS

Series Trip

The most popular configuration for magnetic protectors is the series trip where the sensing coil and contacts are in series with the load being protected. The handle position conveniently indicates circuit status. In addition to providing conventional overcurrent protection, it's simultaneously used as an on-off switch.

Shunt Trip

The shunt trip is designed for controlling two separate loads with one assembly. The control is established by providing overload protection for the critical load. When the current through this load becomes excessive and reaches the trip point, the protector will open and remove power from both loads simultaneously. The total current rating of both loads must not exceed the maximum contact rating.

Dual Coil

By combining two electrically independent coils on a common magnetic circuit, it is possible to provide contact opening when either an over-current or trip voltage is applied to the respective coils. One coil will be a current trip coil with standard specifications. The second, or dual coil, can be used to provide a control function permitting contact opening from a remote interlock or other transducer functions. Standard coils are 6, 12, 24, 48, 120 and 240 volts. Tripping is instantaneous and must be removed (usually self-interrupting) after trip.

Auxiliary Switch (Applies to Series Trip Only)

This is furnished as an integral part of a series pole in single or multi-pole assemblies. Isolated electrically from the protector's circuit, the switch works in unison with the power contacts and provides indication at a remote location of the protector's on-off status.

Auxiliary switch contacts actuate simultaneously with the main breaker contacts, and will open regardless of whether the breaker contacts are opened manually or electrically. For auxiliary switch ratings below 6Vac or 5Vdc, an auxiliary switch with gold contacts, designated as REG is available. Gold contacts are not recommended for load current above 100 milliamps.

Note:

- Terminal protrusion dimensions are referenced from back of mounting panel.
- Each screw terminal is supplied with a 10-32x.312[7.92] or M5 x 8mm screw, flatwasher and external tooth lockwasher.
- Stud terminals are supplied with a flatwasher, external tooth lock washer and a 10-32 or M5 hex nut ($\leq 70A$), 1/4-20 or M6 hex nut ($>70A$).

Series and Switch Only

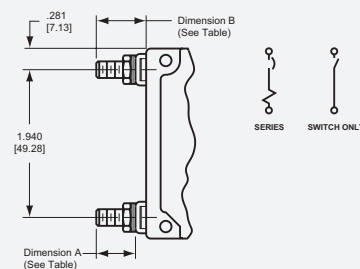

Series with Auxiliary Switch

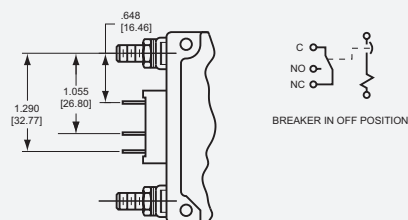

STUD TERMINAL TYPES

| Screw Stud Thread | Dimension "A" | Dimension "B" |
|-------------------|-------------------------------|-------------------------------|
| M6 | .510 ± .045 [12.95 ± 1.14] | .652 ± .035 [16.56 ± 0.89] |
| 1/4 -20 | .545 ± .045 [13.84 ± 1.14] | .687 ± .035 [17.45 ± 0.89] |
| M5 | .510 ± .045 [12.95 ± 1.14] | .652 ± .035 [16.56 ± 0.89] |
| 10-32 | .545 ± .045 [13.84 ± 1.14] | .687 ± .035 [17.45 ± 0.89] |

Shunt and Dual Coil

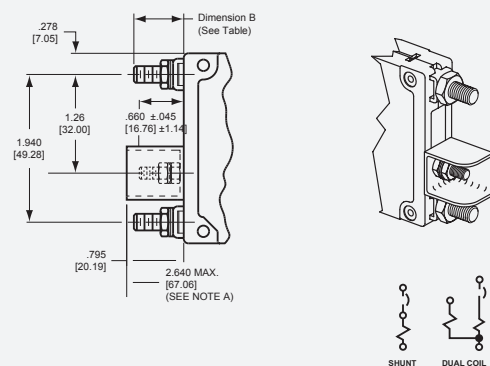

Spacing for VDE Switch

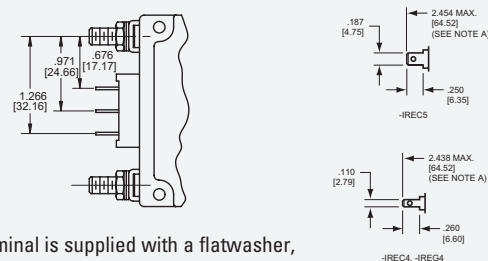

Note: Each outer terminal is supplied with a flatwasher, tooth lockwasher and a hex nut.

CONFIGURATIONS (CONT.)

Relay Trip

This permits the overload sensing coil to be placed in a circuit which is electrically isolated from the trip contacts. The coil may be actuated by sensors monitoring pressure, flow, temperature, speed, etc. Other typical applications include crowbar, interlock and emergency/rapid shutdown circuitry. Trip may be accomplished by voltage or current, which must be removed after trip.

Voltage Trip

Sometimes called "dump circuits" or "panic trip circuits," these units make it possible to open main power contacts with lower power inputs from one or more sources. This configuration is becoming increasingly more important for sensitive circuitry and denser packaging in automation systems. Available in series, shunt or relay configurations.

Relay and Dual Coil

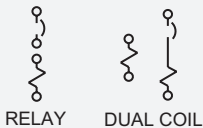
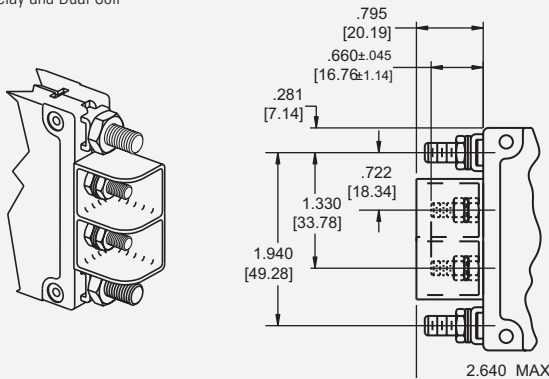

Notes:

- Tolerance $\pm .015$ [3.9] unless noted. Dimensions in brackets [] are millimeters.
- A Terminal protrusion dimensions are referenced from back of mounting panel.
- B Each screw terminal is supplied with a 10-32x.312[7.92] or M5 x 8mm screw, flatwasher and external tooth lockwasher.
- C Stud terminals are supplied with a flatwasher, external tooth lockwasher and a 10-32 or M5 hex nut ($\leq 70A$), 1/4 -20 or M6 hex nut ($>70A$).

Barriers

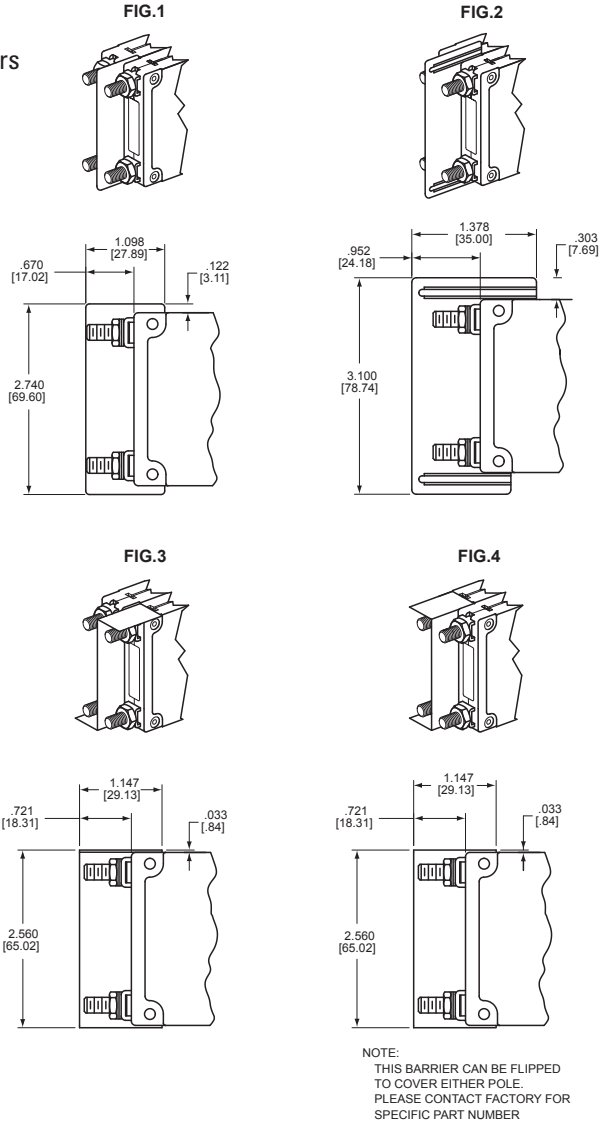

NOTE:
THIS BARRIER CAN BE FLIPPED TO COVER EITHER POLE.
PLEASE CONTACT FACTORY FOR SPECIFIC PART NUMBER

BARRIER OPTIONS

| Rating Option | Standard Barrier | Optional Barrier |
|---|------------------|------------------|
| IEL | | |
| 240/415 VAC | Fig. 1 | Fig. 2, 3 & 4 |
| 415 VAC (VDE) | | |
| 277/480 VAC | | |
| 1/4-20, M6 studs for AC | Fig. 2 | Fig. 3 & 4 |
| 120/240 VAC multi-pole | | |
| 125VDC | | |
| LEL | | |
| All multi-pole 50/60 Hz | Fig. 2 | Fig. 3 & 4 |
| All multi-pole 80 VDC, if opposite polarity | Fig. 2 | Fig. 3 & 4 |
| 125VDC | Fig. 2 | Fig. 3 & 4 |

Note: Optional barrier available with factory assigned part number. Contact factory for assistance.

Mid-Trip Indication

Circuit protection, rapid fault location and alarm capability are blended together in the Airpax mid-trip indication option. This option is designed for automatic handle movement to a middle position upon electrical overload, allowing for easier detection of the fault circuit and minimizing downtime due to the overload condition.

In the optional auxiliary switch configuration, the switch allows an alarm or signal to be forwarded when the breaker trips and the handle moves to the middle position. The alarm can be disengaged by the manual actuation of the handle to the OFF position. Once the fault has been corrected, the circuit breaker can be reset to the ON position. The mid-trip option is available in one, two or three pole toggle handle packages and in either standard panel screw or snap-in mounting. Please see specification tables of specific product for available ratings.

Snap-In Mounting

The snap-in mounting adapter allows for simplified mounting of most IEL/LEL toggle handle products. Prior to shipment, the adapter is attached to the circuit breaker during our final product assembly, allowing you to securely snap the unit into a rectangular panel cut-out. This eliminates the need for panel mounting hardware and associated assembly costs.

Available for units up to three poles, with or without an option handle guard.

Note: Tolerance $\pm .015$ [.39] unless noted.
Dimensions in brackets [] are millimeters.

Panel Mounting Detail
Tolerance $\pm .005$ [.13] unless noted.

Mid-Trip Handle Positions

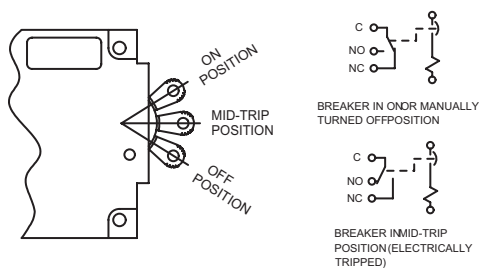

Panel Mounting Detail

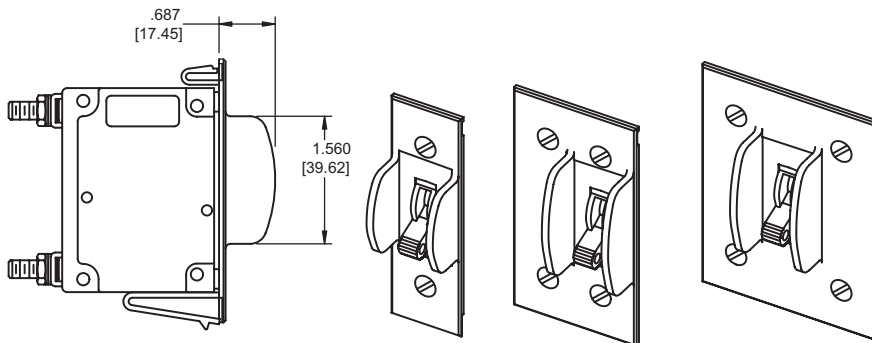
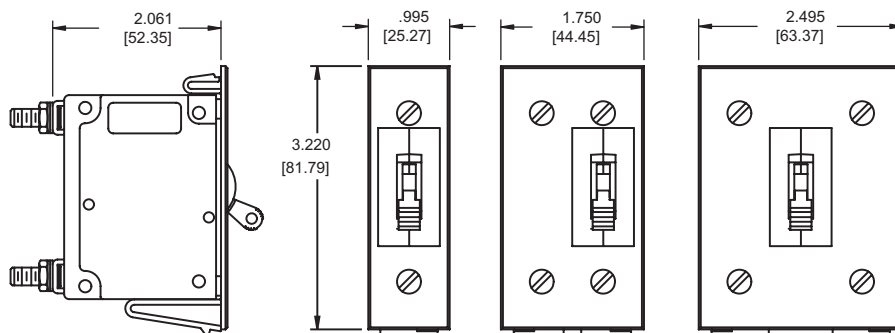
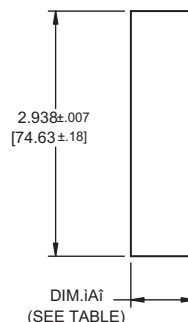

| PANEL MOUNTING OPTIONS | | |
|------------------------|---------------------------------------|-------------------------------------|
| # of Poles | Dimension "A" | Panel Thickness |
| 1 pole | .760 \pm .007 [19.30 \pm .18] | .062 \pm .005 [1.57 \pm .13] |
| 2 pole | 1.530 \pm .007 [38.86 \pm .18] | .062 \pm .005 [1.57 \pm .13] |
| 3 pole | 2.280 \pm .007 [57.91 \pm .18] | .062 \pm .005 [1.57 \pm .13] |

OPERATING CHARACTERISTICS

| NOMINAL DCR /IMPEDANCE | | | |
|---------------------------|-------------------|--------------------|------------------|
| Current Ratings (Amps) | Resistance (ohms) | Impedance (ohms) | Impedance (ohms) |
| | DC Delays | AC, 50/60Hz Delays | AC, 400Hz Delays |
| | 51, 52, 53, 59 | 61, 62, 63, 69 | 41, 42, 43, 49 |
| 0.20 | 45.8 | 28.5 | 71.94 |
| 1.0 | 1.38 | 1.10 | 2.85 |
| 2.0 | 0.371 | 0.29 | 0.76 |
| 5.0 | 0.055 | 0.051 | 0.12 |
| 10.0 | 0.017 | 0.016 | 0.032 |
| 20.0 | 0.006 | 0.006 | 0.010 |
| 30.0 | 0.003 | 0.004 | 0.006 |
| 50.0 | 0.0019 | 0.0018 | 0.0019 |
| 60.0 | 0.00157 | 0.00134 | — |
| 70.0 | 0.00147 | 0.00133 | — |
| 80.0 | 0.00146 | 0.00123 | — |
| 90.0 | 0.00135 | 0.00114 | — |
| 100.0 | 0.00135 | 0.00114 | — |
| 125.0 | 0.0005 | — | — |
| 150.0** | 0.0005 | — | — |
| 165.0** | 0.0004 | — | — |
| 175.0** | 0.0004 | — | — |
| 200.0** | 0.0004 | — | — |
| 250.0** | 0.0004 | — | — |
| 400** | 0.0003 | — | — |

Notes:
 DCR and impedance based on 100% rated current applied and stabilized a minimum of one hour.
 No 53 delay on 125 amp single pole or 400 amp four pole devices
 Tolerance: .02 amperes to 2.5 amperes, ± 20%; 2.6 amperes to 20 amperes, ± 25%; 21 amperes to 50 amperes, ± 50%. Consult factory for special values and for coil impedance of delays not shown
 ** Paralleled poles only, 400 amps only available on CELHP

PERCENTAGE OF RATED CURRENT VS TRIP TIME IN SECONDS AT +25°C

| Delay | 100% | 125%* | 150% | 200% | 400% | 600% | 800% | 1000% |
|-------|---------|------------|-----------|------------|------------|-------------|-------------|-------------|
| 41* | No Trip | May trip | .5 to 8 | .15 to 1.9 | .02 to .4 | .006 to .25 | .004 to .1 | .004 to .05 |
| 42* | No Trip | May trip | 5 to 70 | 2.2 to 25 | .40 to 5 | .012 to 2 | .006 to .2 | .006 to .15 |
| 43* | No Trip | May trip | 35 to 350 | 12 to 120 | 1.5 to 20 | .012 to 2.2 | .01 to .22 | .01 to .1 |
| 49* | No Trip | May trip | .100 max. | .050 max. | .020 max. | .020 max. | .020 max. | .020 max. |
| 51 | No Trip | .5 to 6.5 | .3 to 3 | .1 to 1.2 | .031 to .5 | .011 to .25 | .004 to .1 | .004 to .08 |
| 52 | No Trip | 2 to 60 | 1.8 to 30 | 1 to 10 | .15 to 2 | .04 to 1 | .008 to .5 | .006 to .1 |
| 53** | No Trip | 80 to 700 | 40 to 400 | 15 to 150 | 2 to 20 | .23 to 9 | .015 to .55 | .012 to .2 |
| 59 | No Trip | .120 max. | .100 max. | .050 max. | .022 max. | .017 max. | .017 max. | .017 max. |
| 61 | No Trip | .7 to 12 | .35 to 7 | .130 to 3 | .030 to 1 | .015 to .3 | .01 to .15 | .008 to .1 |
| 62 | No Trip | 10 to 120 | 6 to 60 | 2 to 20 | .2 to 3 | .02 to 2 | .015 to .8 | .01 to .25 |
| 63 | No Trip | 50 to 700 | 30 to 400 | 10 to 150 | 1.5 to 20 | .4 to 10 | .013 to .85 | .013 to .5 |
| 69 | No Trip | .120 max | .100 max. | .050 max. | .022 max. | .017 max. | .017 max. | .017 max |
| 71 | No Trip | .44 to 10 | .3 to 7 | .100 to 3 | .030 to 1 | .012 to .3 | .004 to .15 | .004 to .1 |
| 72 | No Trip | 1.8 to 100 | 1.7 to 60 | 1 to 20 | .15 to 3 | .015 to 2 | .008 to .79 | .006 to .28 |
| 73 | No Trip | 50 to 600 | 30 to 400 | 10 to 150 | 1.8 to 20 | .015 to 10 | .015 to .88 | .011 to .5 |
| 79 | No Trip | .120 max | .100 max. | .050 max. | .023 max. | .016 max. | .015 max. | .015 max |

Notes:

All trip curves and trip currents are specified with the protector mounted in the normal vertical position at ambient temperature of +25° C. Protectors do not carry current prior to application of overload. A: Ratings above 30 amps may deviate from the above limits by approximately 10% (130% for delay 49).

* No 53 delay on 125 amp single pole or 400 amp four pole devices

* 135% for delay 71, 72, 73 & 79

DELAY CURVES

400Hz, DC, 50/60Hz Delay Curves (typ)

A choice of delays is offered for DC, 50/60Hz, 400Hz, or combined DC/50/60Hz applications. Delays 49, 59, 69 and 79 provide fast-acting, instantaneous tripping and are often used to protect sensitive electronic equipment (not recommended where a known inrush exists). Delays 41, 51, 61 and 71 have a short delay for general purpose applications. Delays 42, 52, 62 and 72 are long enough for most transformers and capacitor loads. Delays 43, 53, 63 and 73 are extra long for special motor applications.

Inrush Pulse Tolerance

Pulse tolerance is defined as a single pulse of half sine wave peak current amplitude of 8 milliseconds duration that will not trip the circuit breaker.

The table on page 171 provides a guide to determine if the inertia delay feature is required. Consult factory for further assistance.

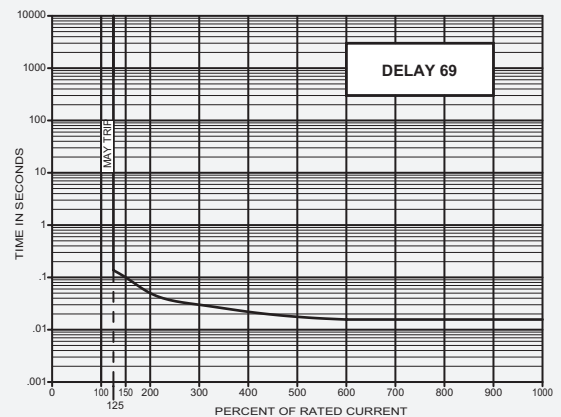
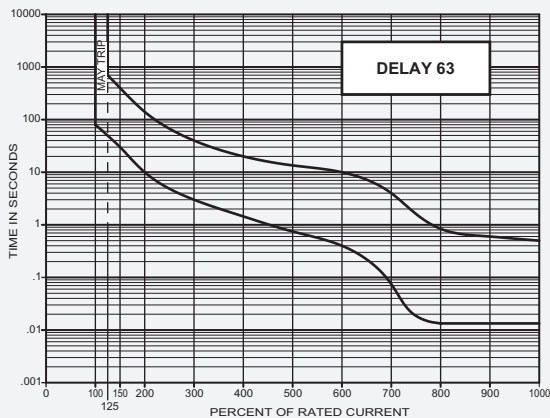
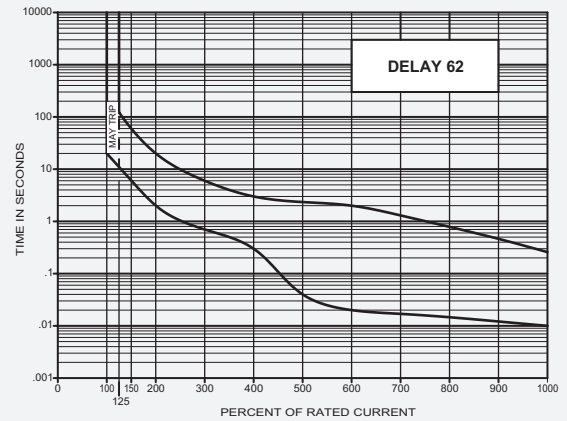
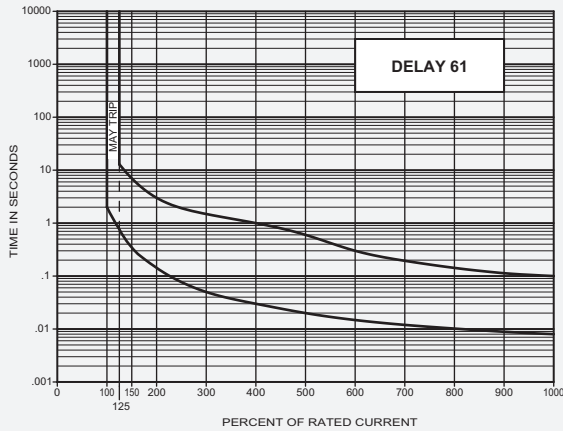

DC Delay Curves (typ)

| PULSE TOLERANCES | |
|------------------------------|----------------------------------|
| Delay | Pulse Tolerance |
| 61, 62, 63, 71, 72, 73 | 10 times (approx.) rated current |
| 61F, 62F, 63F, 71F, 72F, 73F | 12 times (approx.) rated current |
| 64, 65, 66 (0 - 50A) | 25 times (approx.) rated current |
| 64, 65, 66 (>50 - 80A) | 20 times (approx.) rated current |
| 64, 65, 66 (>80 - 100A) | 18 times (approx.) rated current |

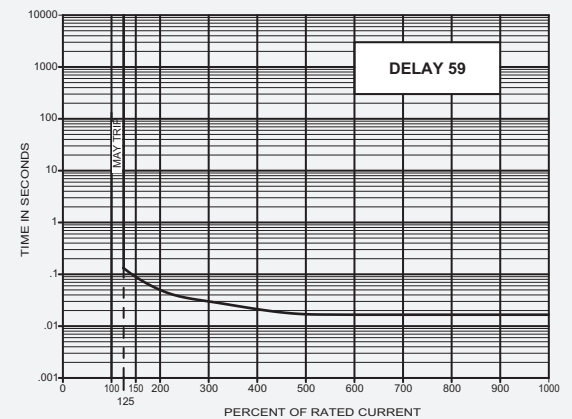
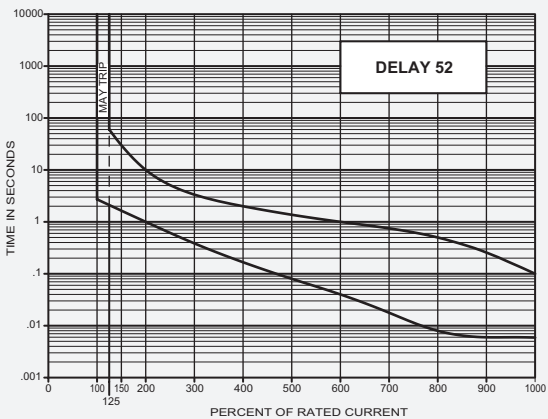
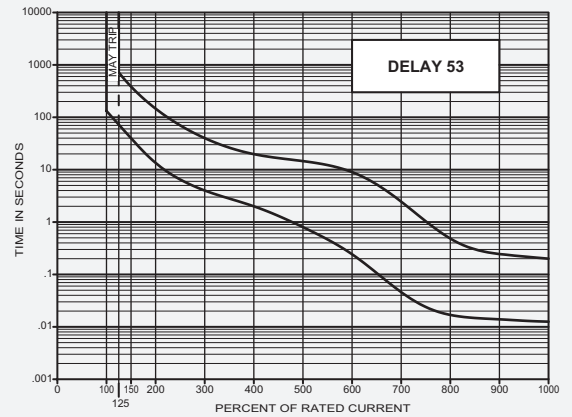
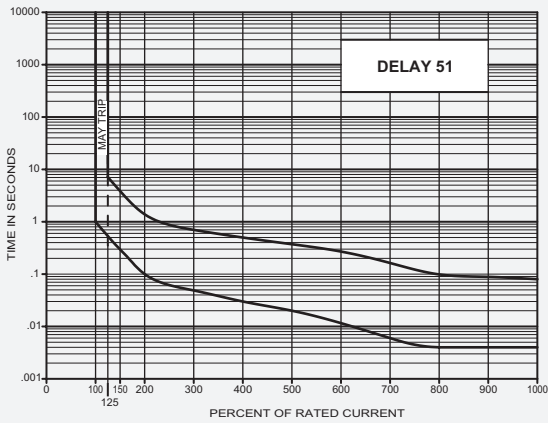

400Hz Delay Curves (typ)

*Available only in IAL/IUL/IEL; not available in LEL.

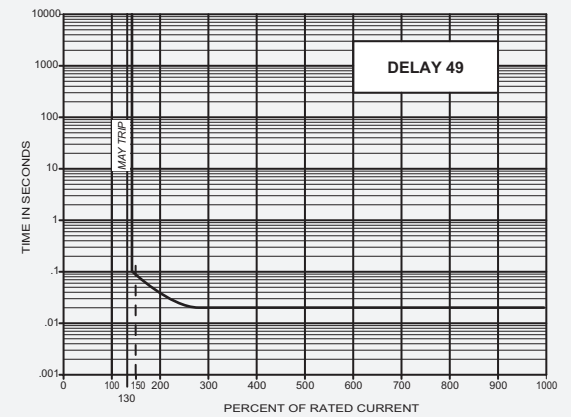
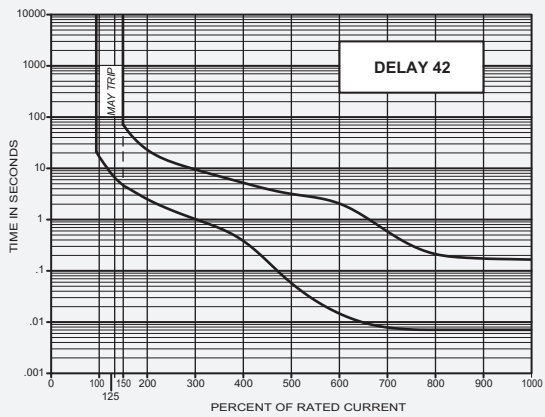
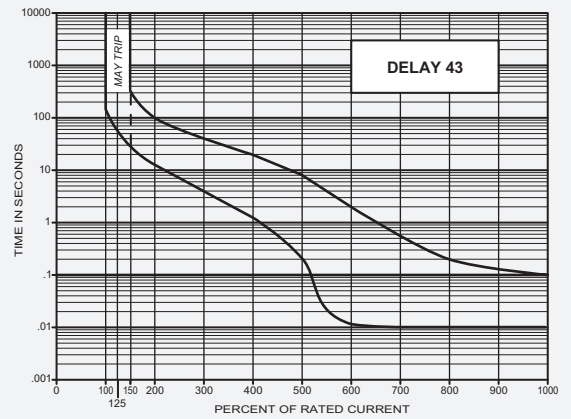
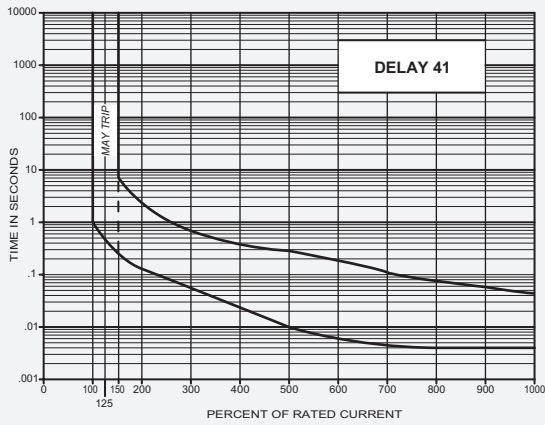

DC/50/60Hz Dual-frequency Delay Curves (typ)

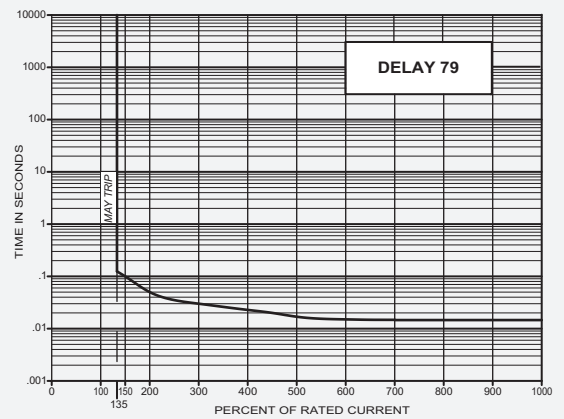
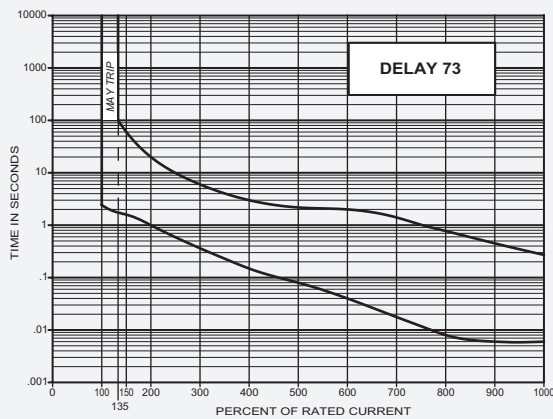
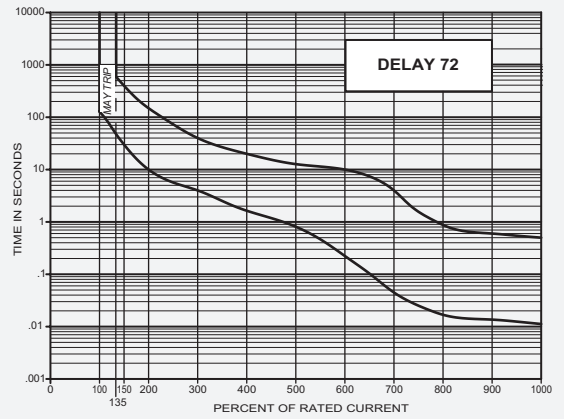
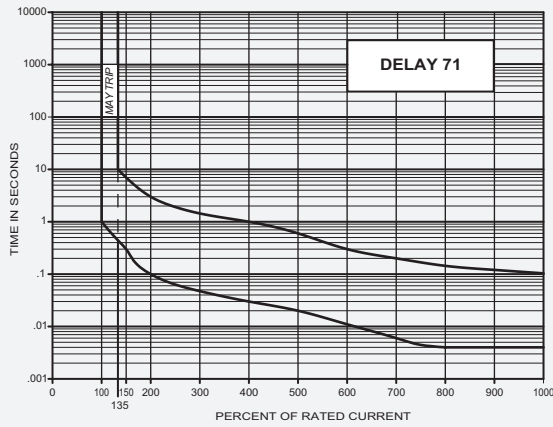

IAL/IUL/IEL/IDL/LEL SPECIFICATIONS

Trip Free

Will trip open on overload even when forcibly held in the ON position. This prevents the operator from damaging the circuit by holding the breaker on.

Trip Indication

The operating handle moves positively to the OFF or mid-trip position on electrical overload.

Ambient Operation

IAL/IUL/IEL protectors operate in temperatures between -40°C to +85°C.

Insulation Resistance

Not less than 100 megohms at 500 volts DC.

Dielectric Strength

IAL/IUL/IEL protectors withstand 3750Vac (1250Vac for LEL), 60Hz for 60 seconds between all electrically isolated terminals except auxiliary switch terminals shall withstand 600Vac, 60Hz for REG and REC types. Four terminal dual coil and relay construction (not offered in the LEL) will withstand 1500Vac.

Endurance

Operating as a switch, the operating life exceeds 10,000 operations, 6000 at rated load, 4000 without load, at a rate of 6 per minute.

Electrical Characteristics

.050-100 amperes 80Vdc, 240Vac Max., 240/415Vac at 50 amperes Max., 50/60Hz and 400Hz. Consult factory for specific product ratings. Units rated for 240/415Vac and above 50 amperes are not suitable for across-the-line motor starting.

Poles

One through six poles available.

Construction

Series, shunt, relay dual coil and series with auxiliary switch available in various delays and combinations.

Auxiliary Switch

When supplied shall be S.P.D.T. configuration. Non VDE approved switches have a maximum UL rating of 10.0 amperes, 250 volts, 60Hz; 3.0 amperes, 50 volts DC (REC type) or 0.1 amperes, 125 volts, 60Hz (REG type).

VDE approved switches have a maximum UL rating of 10.0 amperes, 250 volts, 60Hz (REC type); or 0.1 amperes, 125 volts, 60Hz (REG type). The maximum VDE ratings are 1.0 amperes, 125 volts, 60Hz (REC type); 0.1 amperes, 125 volts, 60Hz (REG type).

Salt Spray (Corrosion)

Meet the requirements of MIL-PRF-55629 when tested in accordance with Method 101 of MIL-STD-202.

Moisture Resistance

Meet all the requirements of MIL-PRF-55629 when tested in accordance with Method 106 of MIL-STD-202.

Shock

Circuit protectors shall not trip when tested per MIL-STD-202, Method 213, Test Condition I with 100% rated current applied to delayed units and 80% rated current to instantaneous units.

Vibration

Circuit protectors shall not trip when vibrated per MIL-STD-202, Method 204, Test Condition A with 100% rated current applied to delayed units and 80% rated current to instantaneous units.

UL-1500 (Marine Ignition Protected)

The IDL/IDLH is approved for Marine Ignition Protection (series configuration only), covering ignition protected circuit breakers. This specification requires devices to be used in accordance with the requirements of U.S. Coast Guard and Fire Protection Standard for Pleasure and Commercial Motor Craft, ANSI/MFPA #302.

APPROXIMATE WEIGHT PER POLE

| Ounces | Grams |
|--------|-------|
| 3.1 | 90 |

RECOMMENDED TORQUE SPECIFICATIONS

| Component | Torque (in-lbs) |
|---------------------------|-----------------|
| 6-32 Mounting Inserts | 6 to 8 |
| M3 Mounting Screws | 4 to 5 |
| 10-32 Screw Terminals | 14 to 15 |
| M5 Terminal Screws | 14 to 15 |
| 10-32 Stud Terminals | 13 to 14 |
| M5 Stud Terminals | 13 to 14 |
| 1/4 - 20 Stud Terminals | 40 to 45 |
| M6 Stud Terminals | 40 to 45 |
| 1/2 - 32 Mounting Bushing | 30 to 35 |

Where applicable, mechanical support must be provide to the terminals when applying torque

IAL/IUL/IEL/IDL/LEL/LELHP SPECIFICATIONS

AGENCY APPROVALS - IAL/IUL/IEL

| Voltage | Frequency (Hz) | Phase | Min. Poles | TC | OL | UL/CSA | VDE (amps) | UL 1077 & CSA (AIC) | VDE (AIC) |
|------------|----------------|-------|------------|----|----|----------|------------|---------------------|-----------|
| 65 | DC | - | 1 | 1 | 1 | .02-100 | .10-70 | U2, 7500 | 4000 |
| 65(4) | DC | - | 1 | 1 | 1 | .02-100 | - | U2, 3000 | - |
| 65(4) | DC | - | 1 | 1 | 1 | .02-50 | - | U2, 5000 | - |
| 65 | DC | - | 2** | 2 | 1 | 101-150 | - | U2, 7500 | - |
| 80 | DC | - | 1 | 1 | 1 | .02-70 | .10-50 | U2, 7500 | 4000 |
| 80 | DC | - | 1 | 1 | 1 | 70.1-100 | - | U2, 5000 | - |
| 80 | DC | - | 2 | 1 | 1 | 101-150 | - | U1, 10000 | - |
| 80 | DC | - | 3 | 1 | 0 | 251-300 | - | U2, 7500 | - |
| 125 | DC | - | 2 | 1 | 0 | .02-100 | - | U2, 5000 | - |
| 250 | DC | - | 2+ | 1 | 0 | .02-50 | - | U1, 5000 | - |
| 300 | DC | - | 3++ | 1 | 0 | .02-50 | .10-50 | U2, 1000 | 5000 |
| 125 | 50/60 | 1 | 1 | 1 | 0 | .02-70 | - | U2, 5000 | - |
| 125 | 50/60 | 1 | 1 | 1 | 1 | .02-100 | - | U1, 3000 | - |
| 125(5) | 50/60 | 1 | 1 | 1 | 1 | .02-100 | - | U3, 1500 | - |
| 120/240 | 50/60 | 1 | 2 | 2 | 1 | .02-100 | - | U1, 2000 | - |
| 125/250(5) | 50/60 | 1 | 2 only | 1 | 1 | .02-100 | - | U3, 1500 | - |
| 240 | 50/60 | 1&3 | 1 | 1 | 0 | .02-70 | - | U1, 2000 | - |
| 240 | 50/60 | 3 | 2 | 1 | 1 | .02-100 | - | U2, 2000 | - |
| 250 | 50/60 | 3 | 1 | 1 | 1 | .02-50 | .10-100 | U2, 3000 | 2000 |
| 250 | 50/60 | 3 | 1 | 1 | 1 | .02-50 | .10-100 | C2, 5000(1) | 2000 |
| 250 | 50/60 | 1 | 1 | 1 | 1 | .02-50 | .10-100 | C2, 5000(2) | 2000 |
| 250 | 50/60 | 3 | 2 | 1 | 0 | .02-80 | .10-100 | U1, 1000 | 2000 |
| 250 | 50/60 | 3 | 1 | 1 | 0 | .02-60 | .10-100 | U1, 5000 | 2000 |
| 250(5) | 50/60 | 3 | 3 only | 1 | 1 | .02-100 | - | U3, 2000 | - |
| 277 | 50/60 | 1 | 1 | 1 | 1 | .02-50 | - | U2, 2000 | - |
| 277 | 50/60 | 1&3 | 1 | 2 | 1 | .02-50 | - | C2, 5000(1) | - |
| 240/415 | 50/60 | 3 | 2 | 2 | 0 | .02-50 | .10-50 | U2, 2000 | 2000 |
| 240/415 | 50/60 | 1 | 2 | 2 | 0 | .02-50 | .10-50 | C2, 5000(1) | 2000 |
| 277/480 | 50/60 | 3 | 2 | 2 | 1 | .02-30 | - | U2, 2000 | - |
| 277/480 | 50/60 | 3 | 2 | 2 | 1 | .02-50 | - | U2, 1200 | - |
| 277/480 | 50/60 | 3 | 2 | 1 | 1 | .02-30 | - | C2, 5000(3) | - |
| 277480 | 50/60 | 1&3 | 2 | 1 | 0 | .02-50 | - | C2, 5000(3) | - |
| 480 | 50/60 | 1&3 | 2 | 1 | 1 | .02-30 | - | C2, 5000(3) | - |
| 480 | 50/60 | 3 | 2 | 1 | 0 | .02-50 | - | C2, 5000(3) | - |
| 250 | 400 | 1&3 | 1 | 2 | 1 | .02-50 | - | U2, 1500 | - |

AGENCY APPROVALS - LEL/LELHP

| Voltage | Frequency (Hz) | Phase | Min. Poles | UL/CSA | VDE (amps) | UL489 (AIC) | VDE (AIC) |
|---------|----------------|-------|------------|---------|------------|-------------|-----------|
| 65 | DC | - | 1 | .05-50 | - | 7500 | - |
| 65 | DC | - | 2** | 101-150 | - | 50 000 | - |
| 65 | DC | - | 3** | 175-200 | - | 50000 | - |
| 80 | DC | - | 1 | .05-100 | .10-100 | 10000 | 2000 |
| 80 | DC | - | 1 | .05-100 | - | 50000 | - |
| 80 | DC | - | 2** | 125-150 | 125-150 | 10000 | 2000 |
| 80 | DC | - | 3** | 175-200 | 151-200 | 10000 | 2000 |
| 125 | DC | - | 1 | .05-70 | .05-70 | 5000 | 3000 |
| 125/250 | DC | - | 2 | .05-50 | - | 5000 | - |
| 125 | 50/60 | 1&3 | 1 | .05-40 | - | 10000 | - |
| 125 | 50/60 | 1&3 | 1 | .05-50 | .10-50 | 5000 | 2000 |
| 120/240 | 50/60 | 1 | 2 | .05-70 | .10-50 | 5000 | 2000 |
| 240 | 50/60 | 1&3 | 1 | .05-20 | - | 5000 | - |

AGENCY APPROVALS - CELHP

| | | | | | | | |
|----|----|---|---|-----|---|--------------------|---|
| 80 | DC | - | 4 | 400 | - | 10000 AIC (UL489A) | - |
|----|----|---|---|-----|---|--------------------|---|

AGENCY APPROVALS - CEL/CELP (COMMUNICATIONS)

| Voltage | Frequency (Hz) | Phase | Min. Poles | UL/CSA | VDE (amps) | UL 489A (AIC) | VDE (AIC) |
|---------|----------------|-------|------------|----------|------------|---------------|-----------|
| 65 | DC | - | 1 | .05-50 | - | 7500 | - |
| 65 | DC | - | 2** | 101-150 | - | 50000 | - |
| 80 | DC | - | 1 | .05-100 | - | 50000 | - |
| 80 | DC | - | 2** | 101-200 | - | 10000 | - |
| 80 | DC | - | 3** | 201-250 | - | 10000 | - |
| 125 | DC | - | 1 | .05-70 | - | 5000 | - |
| 80 | DC | - | 1 | 15.1-125 | - | 10000 | - |

AGENCY APPROVALS - IDL/IDLP (MARINE)

| Voltage | Frequency (Hz) | Phase | Min. Poles | TC | OL | UL/CSA | VDE (amps) | UL 1077 & CSA (AIC) | VDE (AIC) |
|---------|----------------|-------|------------|----|----|---------|------------|---------------------|-----------|
| 48 | DC | - | 1 | 1 | 1 | .02-100 | - | U1, 5000 | - |
| 48 | DC | - | 2** | 1 | 1 | 101-150 | - | U1, 5000 | - |
| 65 | DC | - | 1 | 1 | 1 | .02-60 | - | U1, 1000 | - |
| 80 | DC | - | 1 | 1 | 1 | .02-100 | - | U2, 1500 | - |
| 125 | 50/60 | 1 | 1 | 1 | 1 | .02-100 | - | U 1, 1500 | - |
| 250 | 50/60 | 1 | 2 | 1 | 1 | .02-100 | - | U2, 1500 | - |
| 250 | 50/60 | 1&3 | 1 | 1 | 1 | .02-60 | - | U1, 1000 | - |

AGENCY APPROVALS - IULQ (TAPPED COIL)

| Voltage | Frequency (Hz) | Phase | Min. Poles | TC | OL | UL/CSA | VDE (amps) | UL 1077 & CSA (AIC) | VDE (AIC) |
|---------|----------------|-------|------------|----|----|-----------|------------|---------------------|-----------|
| 125/250 | 50/60 | 1 | 1 | 1 | 1 | 2/1-30/15 | - | C2, 5000(1) | - |

AGENCY APPROVALS - IULD (DUST SEALED)

| Voltage | Frequency (Hz) | Phase | Min. Poles | TC | OL | UL/CSA | VDE (amps) | UL 1077 & CSA (AIC) | VDE (AIC) |
|---------|----------------|-------|------------|----|----|---------|------------|---------------------|-----------|
| 250 | 50/60 | 1&3 | 1 | 1 | 1 | .02-100 | - | C2, 5000(3) | - |
| 277 | 50/60 | 1 | 1 | 1 | 1 | .02-30 | - | C2, 5000(3) | - |

Notes:

** Paralleled poles; + 2 poles in series; ++ 3 poles in series; (1) With 125 A max. series fuse; (2) Series combination with 209 or 229 series (100 A max.); (3) With 100 A max. series fuse; (4) With blocked vent construction (5) Non-standard construction. "Fit for further use" approval

General notes:

- All supplementary protectors are of the overcurrent (OC) type
- The family of protectors has been evaluated for end use application for use groups (UG) A, B, C and D
- The terminals (FW) are suitable for factory wiring only (0)
- The maximum voltage ratings for which the protectors have been tested are shown in the chart
- The current is the amperage range that the protectors have been tested
- The tripping current (TC) for all of the protectors is either either "1" (in the range of 125% to 135% of ampere rating) or "2" (more than 135% of ampere rating)
- The overload rating (OL) – designates whether the protector has been tested for general use or motor starting applications.

0 – tested at 1.5 times amp rating for general use

1 – tested at 6 times AC rating or 10 times DC rating for motor starting

- The short circuit current rating (SC) – The short circuit rating in amperes following a letter and number designating the test conditions and any calibration following the short circuit test is defined below:

C – Indicates short circuit test was conducted with series overcurrent protection

U – Indicates short circuit test was conducted without series overcurrent protection

1 – Indicates a recalibration was not conducted as part of the short circuit testing

2 – Indicates a recalibration was performed as part of the short circuit testing

3 – Indicates recalibration was performed along with the dielectric and voltage withstand for "Suitable for Further Use" rating

IAL/IUL/IEL DECISION TABLES

The ordering code for IAL/IUL/IEL/LEL circuit protectors may be determined by following the decision steps in the appropriate part number decision table subsequent to this page.

The coding given permits a self-assigning part number but with certain limitations. Special applications may require a factory assigned part number. Typical examples are units with mixed ratings, combinations of styles, or constructions not listed in the third decision table, etc. With these, it is suggested that order entry be by description and/or drawings, and a part number will be established. Additionally, it is standard policy to establish a factory-assigned part number whenever a descriptive drawing exists to provide cross reference, traceability and manufacturing control.

When specifying a circuit breaker for AC motor start or high inrush applications, the peak amplitude and surge duration should be specified for factory assistance in rating selection.

For example the code shown is the code for a single pole breaker with a series construction and auxiliary switch, designed for operation in a 50/60Hz circuit. It has a short time delay, rating of 20 amperes and a marked black handle, and is VDE approved.

To determine the ordering number for your particular IAL/IUL/IEL unit, simply follow the steps shown. You may use this number to place an order or as a reference for further questions you may have.

Notes:
IEL, IELH and IELX circuit protectors are designed to meet 8mm creepage clearance requirements for installation Category 111, Pollution Degree 3, Case A as measured in IEC 664. Intended for use in equipment to comply with IEC 950, 601 and VDE 0804 & 0805.

| 1 First Decision | | |
|------------------------------|---|--|
| Select Type and Terminal | | |
| Type | Description | Terminal |
| IAL **IUL ***IEL | One handle per unit | Standard screw terminal, no designation required |
| IALH **IULH ***IELH | One handle per pole | K Stud terminals |
| | | C Clip terminals |
| | | B Bullet terminals |
| IALN **IULN | One handle per unit panel seal | |
| IALX **IULX ***IELX | One handle per unit, rocker, bracket mounting | |
| IALZX **IULZX ***IELZX | One handle per unit, rocker, integral mounting | |
| *IDL | One handle per unit UL 1500 | |
| *IDLH | One handle per pole UL 1500 | |
| **IML | One handle per unit mid trip indication | |
| **IMLH | One handle per pole mid trip indication | |
| IALBX **IULBX ***IELBX | One handle per unit, rocker, accidental-off protection | |
| **IMLBX | One handle per unit, mid trip indication, rocker, accidental-off protection | |

*UL Recognized
**UL Recognized, CSA Certified
***UL Recognized, CSA Certified, VDE Approved

| 2 Second Decision | |
|-------------------|-------------|
| Poles | |
| 1 | Single pole |
| 11 | Two pole |
| 111 | Three pole |
| 1111 | Four pole* |

*Not available in toggle seal handle type. Consult factory for 5 and 6 pole IEL part number.

Example:

IEL 1-1REC4-61-20.0-01-V

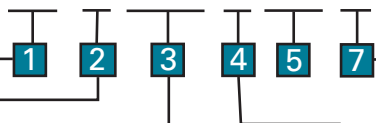

| 3 Third Decision | |
|------------------------|---|
| Internal Configuration | |
| -0 | Switch only (50, 70 or 100 amp switch) |
| -1 | Series |
| -1REC4 | Series with auxiliary switch* .110 quick connect |
| -1REC5 | Series with auxiliary switch* .187 quick connect |
| -1REG4 | Series with auxiliary switch .110 quick connect |
| -1RS4 | Series with alarm switch, electrical trip, .110 quick connect terminals |
| -1RLS4 | Series with alarm switch, electrical trip, .110 quick connect terminals (mid-trip only) |
| -1RS5 | Series with alarm switch, electrical trip, .187 quick connect terminals |
| -3 | Shunt |
| -4 | Relay (not available in IEL/IELX) |

* Only one auxiliary switch is normally supplied on two or three pole units. Switch is located in the right-hand pole (viewed from terminal end) unless otherwise specified.

| 4 Fourth Decision | |
|-------------------|----------------------------|
| Frequency & Delay | |
| SW | Switch only |
| -41 | 400Hz short delay |
| -42 | 400Hz long delay |
| -43 | 400Hz motor start |
| -49 | 400Hz 150% instant trip |
| -51 | DC short delay |
| -52 | DC long delay |
| -53 | DC motor start |
| -59 | DC 125% instant trip |
| -61 | 50/60Hz short delay |
| -62 | 50/60Hz long delay |
| -63 | 50/60Hz motor start |
| -69 | 50/60Hz 125% instant trip |
| -71 | DC/60Hz short delay |
| -72 | DC/60Hz long delay |
| -73 | DC/60Hz motor start |
| -79 | DC/60 Hz 135% instant trip |

For addition of inertial delay, add an iFi to any delay numeral.

V = VDE and CCC Approved

The shaded areas denote VDE and CCC (if applicable) Approval options. This approval requires the addition of a V at the end of the part number. The V will be added to any part number formed entirely from shaded decisions. If non-shaded areas are selected, the unit will not be VDE or CCC Approved, but other approvals still apply.

Note: CCC Approval is pending.

C = CCC Approved

This approval requires the addition of a C at the end of the part number. The unit will not be VDE Approved.

Note: CCC Approval is pending.

5 Fifth Decision

Rated Current

Use three numbers to print required current value between .100 amps minimum and 100 amps maximum.

For example, use: .100 or 2.00 or 10.0

The VDE (Ith) will be 95% of the UL/CSA rated current.

6 Sixth Decision

Optional

| | |
|----|---|
| | Standard hardware. No designation required. |
| -A | Metric thread mounting inserts and terminals |
| -B | Barrier |
| -C | 277V (50/60Hz only) (See note 3) |
| -D | 240/415V (50/60Hz only) |
| -E | 277V/480V (50/60Hz only) (See note 4) |
| -G | Handle guard, (available in ZX, BX and snap-in versions only) |
| -K | 1/4 - 20 stud (M6 stud when -A option is selected) (<=70A requires -K, if >70A do not use -K) |
| -L | Handle lock |
| -M | Handle in opposite pole |
| -P | Snap-in face plate adapter |
| -U | 120/240V 50/60Hz |
| -W | Wire clamp supplied (VDE approved up to and including 16.0 amps) |
| -X | Handle guard with no actuation feature (BX rocker only) |
| -1 | Silver 5/16" (.312") bullet |
| -2 | Gold 5/16" (.312") bullet |

Notes:
 1. One or more descriptions may be used as required.
 2. When this is not used, table one may be substituted and U.S. thread and two lockwashers will be supplied. Unit will be rated at 250V (50/60Hz only).
 3. VDE approved at 250Vac
 4. VDE approved at 415Vac

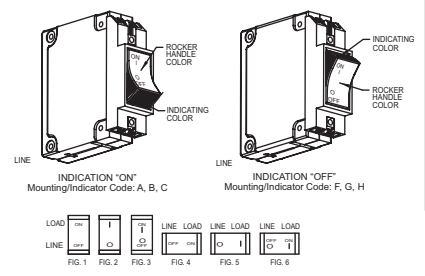

MARKING DETAIL "A" (SEE TABLE)

7 Seventh Decision

Handle Color and Marking Selection

IAL, IUL, IEL, IALH, IULH, IELH - Toggle Handle

| Color | Unmarked | Marked* ON-OFF I-O |
|--------|----------|--------------------|
| Black | -00 | -01 (STD) |
| Yellow | -10 | -11 |
| Red | -20 | -21 |
| Blue | -30 | -31 |
| Green | -40 | -41 |
| Orange | -60 | -61 |
| White | -90 | -91 |

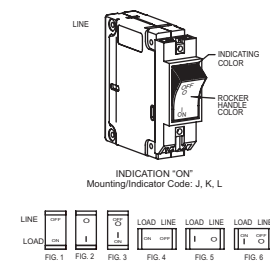

MARKING DETAIL "B" (SEE TABLE)

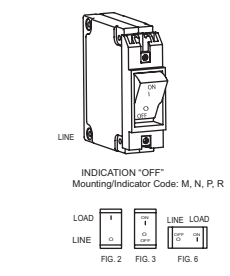

MARKING DETAIL "C" (SEE TABLE)

7 Seventh Decision

Rocker Handle Color, Indicator Color and Marking Selection (See Notes)

IALX, IULX, IELX, IALZX, IULZX, IELZX Rocker Handle (Single Rocker Color)

| Rocker Handle Color | Indicating Color | Marking Color | Indicates: | Unmarked | Vertical Mounting | | | Horizontal Mounting | | | Marking Detail |
|---------------------|------------------|---------------|------------|----------|-------------------|-----------|------------------|---------------------|-----------|------------------|----------------|
| | | | | | On-Off Fig.1 | I-O Fig.2 | On-Off I-O Fig.3 | On-Off Fig.4 | I-O Fig.5 | On-Off I-O Fig.6 | |
| Black | N/A | White | N/A | -00 | -01 | -02 | -03 | -04 | -05 | -06 | A |
| Red | N/A | White | N/A | -20 | -21 | -22 | -23 | -24 | -25 | -26 | |
| Grey | N/A | Black | N/A | -40 | -41 | -42 | -43 | -44 | -45 | -46 | |
| Orange | N/A | Black | N/A | -50 | -51 | -52 | -53 | -54 | -55 | -56 | |
| White | N/A | Black | N/A | -90 | -91 | -92 | -93 | -94 | -95 | -96 | |

IALZX, IULZX, IELZX Rocker Handle (Dual Rocker Color)

| | | | | | | | | | | | |
|-------|-------|-------|-----|-----|-----|-----|-----|-----|-----|-----|---|
| Black | White | White | On | -A0 | -A1 | -A2 | -A3 | -A4 | -A5 | -A6 | A |
| Black | Red | White | On | -B0 | -B1 | -B2 | -B3 | -B4 | -B5 | -B6 | |
| Black | Green | White | On | -C0 | -C1 | -C2 | -C3 | -C4 | -C5 | -C6 | |
| Black | White | White | Off | -F0 | -F1 | -F2 | -F3 | -F4 | -F5 | -F6 | |
| Black | Red | White | Off | -G0 | -G1 | -G2 | -G3 | -G4 | -G5 | -G6 | |
| Black | Green | White | Off | -H0 | -H1 | -H2 | -H3 | -H4 | -H5 | -H6 | |

IALBX, IULBX, IELBX, LELBX Rocker Handle (Dual Rocker Color)

| | | | | | | | | | | | |
|-------|--------|--------|-----|-----|-----|-----|-----|-----|-----|-----|---|
| Black | White | White | Off | -M0 | N/A | -M2 | -M3 | N/A | N/A | -M6 | C |
| Black | Red | Red | Off | -N0 | N/A | -N2 | -N3 | N/A | N/A | -N6 | |
| Black | Green | Green | Off | -P0 | N/A | -P2 | -P3 | N/A | N/A | -P6 | |
| Black | Yellow | Yellow | Off | -R0 | N/A | -R2 | -R3 | N/A | N/A | -R6 | |

Notes: A. Bezels of IALBX, IULBX, IELB, IELBX are black.
 B. Consult factory for other marking options.

LEL DECISION TABLES

1 First Decision

Select Type and Terminal

| Type | Description | Terminal |
|-------|--|--|
| LEL | One handle per unit | Standard screw terminal, no designation required |
| LELH | One handle per pole | K Stud terminals |
| LML | One handle per unit, mid-trip indication | C Clip terminals |
| LMLH | One handle per pole, mid-trip indication | B Bullet terminals |
| LELZX | One handle per unit, rocker, integral mounting | |
| LMLZX | One handle per unit, rocker, mid-trip indication, integral mounting | |
| LELZX | One handle per unit, rocker, accidental-off protected | |
| LMLZX | One handle per unit, rocker, mid-trip indication, accidental-off protected | |

Note: Other options available, consult factory.

5 Fifth Decision

Rated Current

Use three numbers to print (.050 or 1.50 or 100) Value between **.050** amps and **100** amps.

2 Second Decision

Poles

| | |
|-----|-------------|
| 1 | Single pole |
| 11 | Two pole |
| 111 | Three pole |

6 Sixth Decision

Optional

| | |
|----|---|
| -A | Metric thread mounting inserts and terminals |
| -B | Barrier |
| -F | 240V 50/60Hz |
| -G | Handle guard, (available in ZX, BX and snap-in versions only) |
| -K | 1/4 - 20 Stud (M6 Stud when -A option is selected) (50A requires -K, >50A do not use -K) |
| -L | Handle Lock |
| -M | Handle in opposite pole |
| -P | Snap-in mounting plate adapter |
| -U | 120/240Vac, 5000 A.I.C., 70A max. 2 pole only with barrier (VDE 250Vac) |
| -V | 125VDC |
| -X | Handle guard with no actuate "off" feature (see detail C) |
| -1 | Silver 5/16" (.312") bullet |
| -2 | Gold 5/16" (.312") bullet |

Notes:
1. One or more descriptions may be used as required.
2. When this decision is not used, decision 7 may be substituted and U.S. thread will be supplied.
3. If (M5 or M6) studs are required, use "A" only on an LELK.

3 Third Decision

Internal Configuration

| | |
|--------|---|
| -1 | Series |
| -1REC4 | Series with auxiliary switch .110 quick connect |
| -1REC5 | Series with auxiliary switch .187 quick connect |
| -1REG4 | Series with auxiliary switch (gold contacts) .110 quick connect |
| -1RS4 | Series with alarm switch, electrical trip, .110 quick connect |
| -1RLS4 | Series with alarm switch, electrical trip, .110 quick connect* |

* Used only with mid-trip.

4 Fourth Decision

Frequency and Delay

| | |
|------|---------------------------|
| -51 | DC short delay |
| -52 | DC long delay |
| -53* | DC motor start |
| -59 | DC 125% instant trip |
| -61 | 50/60Hz short delay |
| -62 | 50/60Hz long delay |
| -63 | 50/60Hz motor start |
| -69 | 50/60Hz 125% instant trip |

For addition of inertial delay, add an "F" to any delay numeral.
*Not available above 100 amps.

7 Seventh Decision

LEL Toggle Handle Color Selection

| | |
|-----|--------------------------|
| -01 | Black w/ white markings |
| -11 | Yellow w/ black markings |
| -21 | Red w/ white markings |
| -31 | Blue w/ white markings |
| -41 | Green w/ white markings |
| -61 | Orange w/ black markings |
| -91 | White w/ black markings |

See alternate 7th Decision for ZX and BX Rocker Handles.

Example:

LEL 1 - 1REC4 - 61 - 20.0 - 01 - V

1 2 3 4 5 7

V = VDE and CCC Approved

The shaded areas denote VDE and CCC (if applicable) Approval options. This approval requires the addition of a V at the end of the part number. The V will be added to any part number formed entirely from shaded decisions. If non-shaded areas are selected, the unit will not be VDE or CCC Approved, but other approvals still apply.

C = CCC Approved

The approval requires the addition of a C at the end of the part number. The unit will not be VDE Approved.

Notes: The LEL family of circuit breakers are designed to meet 8mm creepage and clearance requirements for installation Category 111, pollution degree 3, Case A as measured in IEC 664. Intended for use in equipment designed to comply with IEC 380, 435, 601 AND VDE 0730, 0804 & 0805.

7 Seventh Decision

Rocker Handle Color, Indicator Color and Marking Selection (See Notes)

LELZX & LMLZX Rocker Handle (Single Rocker Color)

| Rocker Handle Color | Indicating Color | Marking Color | Indicates: | Unmarked | Vertical Mounting | | | Horizontal Mounting | | | Marking Detail |
|---------------------|------------------|---------------|------------|----------|-------------------|-----------|------------------|---------------------|-----------|------------------|----------------|
| | | | | | On-Off Fig.1 | I-O Fig.2 | On-Off I-O Fig.3 | On-Off Fig.4 | I-O Fig.5 | On-Off I-O Fig.6 | |
| Black | N/A | White | N/A | -00 | -01 | -02 | -03 | -04 | -05 | -06 | A |
| Red | N/A | White | N/A | -20 | -21 | -22 | -23 | -24 | -25 | -26 | |
| Grey | N/A | Black | N/A | -40 | -41 | -42 | -43 | -44 | -45 | -46 | |
| Orange | N/A | Black | N/A | -50 | -51 | -52 | -53 | -54 | -55 | -56 | |
| White | N/A | Black | N/A | -90 | -91 | -92 | -93 | -94 | -95 | -96 | |

LELZX & LMLZX Rocker Handle (Dual Rocker Color)

| | | | | | | | | | | | |
|-------|-------|-------|-----|-----|-----|-----|-----|-----|-----|-----|---|
| Black | White | White | On | -A0 | -A1 | -A2 | -A3 | -A4 | -A5 | -A6 | A |
| Black | Red | White | On | -B0 | -B1 | -B2 | -B3 | -B4 | -B5 | -B6 | |
| Black | Green | White | On | -C0 | -C1 | -C2 | -C3 | -C4 | -C5 | -C6 | |
| Black | White | White | Off | -F0 | -F1 | -F2 | -F3 | -F4 | -F5 | -F6 | |
| Black | Red | White | Off | -G0 | -G1 | -G2 | -G3 | -G4 | -G5 | -G6 | |
| Black | Green | White | Off | -H0 | -H1 | -H2 | -H3 | -H4 | -H5 | -H6 | |

| | | | | | | | | | | | |
|-------|-------|-------|----|-----|-----|-----|-----|-----|-----|-----|---|
| Black | White | White | On | -J0 | -J1 | -J2 | -J3 | -J4 | -J5 | -J6 | B |
| Black | Red | White | On | -K0 | -K1 | -K2 | -K3 | -K4 | -K5 | -K6 | |
| Black | Green | White | On | -L0 | -L1 | -L2 | -L3 | -L4 | -L5 | -L6 | |

LELBX Rocker Handle (Dual Rocker Color)

| | | | | | | | | | | | |
|-------|--------|--------|-----|-----|-----|-----|-----|-----|-----|-----|---|
| Black | White | White | Off | -M0 | N/A | -M2 | -M3 | N/A | -M5 | -M6 | C |
| Black | Red | Red | Off | -N0 | N/A | -N2 | -N3 | N/A | -N5 | -N6 | |
| Black | Green | Green | Off | -P0 | N/A | -P2 | -P3 | N/A | -P5 | -P6 | |
| Black | Yellow | Yellow | Off | -R0 | N/A | -R2 | -R3 | N/A | -R5 | -R6 | |

Notes: A. Bezels of IALBX, IULBX, IELB, IELBX are black.
 B. Consult factory for other marking options.

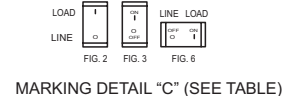
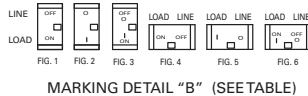
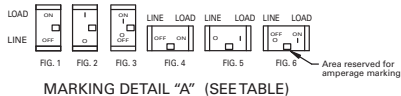
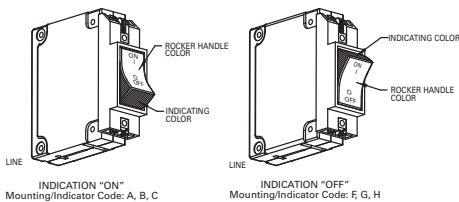

CEL DECISION TABLES

1 First Decision

Select Type and Terminal

| Type | Description | Terminal | |
|-------|---|--|------------------|
| CEL | One handle per unit, UL489A Listed | Standard screw terminal, no designation required | |
| CELH | One handle per pole, UL489A Listed | | |
| CML | Single pole only, one handle per unit mid-trip construction, UL489A Listed | | |
| CMLH | One handle per pole mid-trip construction, UL489A Listed | K | Stud terminals |
| CELZX | One handle per unit, rocker handle, UL489A Listed | C | Clip terminals |
| CMLZX | Single pole only, one handle per unit, rocker handle w/ RLS aux switch, mid-trip construction, UL489A Listed | B | Bullet terminals |
| CELBX | One handle per unit, flat rocker handle, UL489A Listed | | |
| CMLBX | Single pole only, one handle per unit, flat rocker handle w/ RLS aux switch, mid-trip construction, UL489A Listed | | |

2 Second Decision

Poles

| | |
|-----|-------------|
| 1 | Single pole |
| 11 | Two pole |
| 111 | Three pole |

3 Third Decision

Internal Configuration

| | |
|-----------|--|
| -1 | Series |
| -1REC4 | Series with auxiliary switch .110 quick connect |
| -1RLS4 ** | Series with auxiliary switch .110 quick connect, mid-trip only |
| -1REC5 | Series with auxiliary switch .187 quick connect |
| -1RS4 ** | Alarm switch, .110 quick connect |

* Only one auxiliary switch is normally supplied on two and three pole units switch is located in the right hand pole (viewed from terminal end). Note, aux switch followed by "R" indicates reverse mount option
** Not available for 125 amp single pole

4 Fourth Decision

Frequency and Delay

| | |
|------|----------------------|
| -51 | DC short delay |
| -52 | DC long delay |
| -53* | DC motor start |
| -59 | DC 125% instant trip |

For addition of inertial delay, add an "F" to any delay numeral. Example: -51F
*Not available above 100 amps.

5 Fifth Decision

Rated Current

Use three numbers in build (.050 or 1.50 or 100).
Required value between .050 amps minimum and 125 amps maximum.

6 Sixth Decision

Optional

| | |
|----|--|
| -A | Metric thread mounting inserts and terminals |
| -B | Barrier |
| -G | Snap-in mounting plate adapter with handle guard (ZX, BX and snap-in only) |
| -K | 1/4-20 Stud (M6 stud when metric option -A selected) 50A requires -K, >50A do not use -K |
| -P | Snap-in mounting plate adapter |
| -T | 80VDC, 10000AIC, (required over 50A) |
| -V | 125VDC |
| -1 | Silver 5/16" (.312") bullet |
| -2 | Gold 5/16" (.312") bullet |

Notes:
1. One or more descriptions may be used as required.
2. When this decision is not used, decision 7 may be substituted and U.S. thread will be supplied.

7 Seventh Decision

LEL Toggle Handle Color Selection

| | |
|-----|--------------------------|
| -01 | Black w/ white markings |
| -11 | Yellow w/ black markings |
| -21 | Red w/ white markings |
| -31 | Blue w/ white markings |
| -41 | Green w/ white markings |
| -61 | Orange w/ black markings |
| -91 | White w/ black markings |

See alternate 7th Decision for ZX and BX Rocker Handles.

Example:

CEL 1 - 1REC4 - 51 - 20.0 - A - 01 - V

1
2
3
4
5
6
7

V = VDE and CCC Approved

The shaded areas denote VDE and CCC (if applicable) approval options. This approval requires the addition of a V at the end of the part number. The V will be added to any part number formed entirely from shaded decisions. If non-shaded areas are selected, the unit will not be VDE or CCC Approved, but other approvals still apply.

C = CCC Approved

The approval requires the addition of a C at the end of the part number. The unit will not be VDE Approved.

T = TÜV Approved

The approval requires the addition of a T at the end of the part number. The unit will only be TÜV EN60947-2 approved with a single pole, 125 amp rating configuration.

169

CEL Series - Decision Tables

<http://airpax.sensata.com>

7 Seventh Decision

Rocker Handle Color, Indicator Color and Marking Selection (See Notes)

| LELZX & LMLZX Rocker Handle (Single Rocker Color) | | | | | | | | | | | |
|---|------------------|---------------|------------|----------|-------------------|-----------|------------------|---------------------|-----------|------------------|----------------|
| Rocker Handle Color | Indicating Color | Marking Color | Indicates: | Unmarked | Vertical Mounting | | | Horizontal Mounting | | | Marking Detail |
| | | | | | On-Off Fig.1 | I-O Fig.2 | On-Off I-O Fig.3 | On-Off Fig.4 | I-O Fig.5 | On-Off I-O Fig.6 | |
| Black | N/A | White | N/A | -00 | -01 | -02 | -03 | -04 | -05 | -06 | A |
| Red | N/A | White | N/A | -20 | -21 | -22 | -23 | -24 | -25 | -26 | |
| Grey | N/A | Black | N/A | -40 | -41 | -42 | -43 | -44 | -45 | -46 | |
| Orange | N/A | Black | N/A | -50 | -51 | -52 | -53 | -54 | -55 | -56 | |
| White | N/A | Black | N/A | -90 | -91 | -92 | -93 | -94 | -95 | -96 | |
| LELZX & LMLZX Rocker Handle (Dual Rocker Color) | | | | | | | | | | | |
| Black | White | White | On | -A0 | -A1 | -A2 | -A3 | -A4 | -A5 | -A6 | A |
| Black | Red | White | On | -B0 | -B1 | -B2 | -B3 | -B4 | -B5 | -B6 | |
| Black | Green | White | On | -C0 | -C1 | -C2 | -C3 | -C4 | -C5 | -C6 | |
| Black | White | White | Off | -F0 | -F1 | -F2 | -F3 | -F4 | -F5 | -F6 | |
| Black | Red | White | Off | -G0 | -G1 | -G2 | -G3 | -G4 | -G5 | -G6 | |
| Black | Green | White | Off | -H0 | -H1 | -H2 | -H3 | -H4 | -H5 | -H6 | |
| Black | White | White | On | -J0 | -J1 | -J2 | -J3 | -J4 | -J5 | -J6 | B |
| Black | Red | White | On | -K0 | -K1 | -K2 | -K3 | -K4 | -K5 | -K6 | |
| Black | Green | White | On | -L0 | -L1 | -L2 | -L3 | -L4 | -L5 | -L6 | |
| LELZX Rocker Handle (Dual Rocker Color) | | | | | | | | | | | |
| Black | White | White | Off | -M0 | N/A | -M2 | -M3 | N/A | -M5 | -M6 | C |
| Black | Red | Red | Off | -N0 | N/A | -N2 | -N3 | N/A | -N5 | -N6 | |
| Black | Green | Green | Off | -P0 | N/A | -P2 | -P3 | N/A | -P5 | -P6 | |
| Black | Yellow | Yellow | Off | -R0 | N/A | -R2 | -R3 | N/A | -R5 | -R6 | |

Notes: A. Bezels of IALBX, IULBX, IELB, IELBX are black.
 B. Consult factory for other marking options.

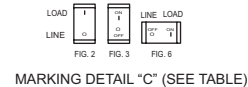
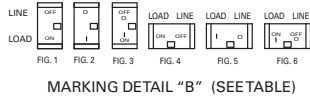
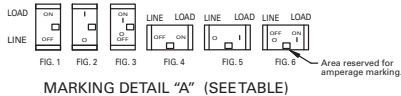
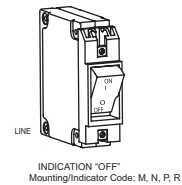
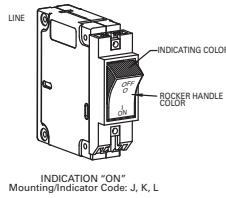
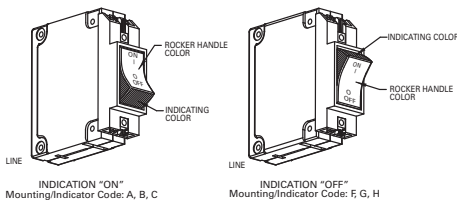

LELHP DECISION TABLES

| 1 First Decision | |
|---------------------------------|---|
| Select Type with Stud Terminals | |
| LELPK | One handle per unit |
| LMLPK | One handle per unit, mid-trip |
| LELZXPk | One ZX rocker handle per unit (integral mounting) |
| LMLZXPk | One ZX rocker handle per unit, mid-trip (integral mounting) |
| LELBXPk | One BX rocker handle per unit (integral mounting) |
| LMLBXPk | One BX rocker handle per unit, mid-trip (integral mounting) |
| LELHPK | One handle per pole |
| LMLHPK | One handle per pole, mid-trip |

1. One toggle handle per unit on 125A to 150A units (2-parallel pole)
2. 175A to 200A (3-parallel pole) requires handle in each pole, "H" selection

| 2 Second Decision | |
|-------------------|------------------------------|
| Poles | |
| 11 | Two pole (up to 150 amps) |
| 111 | Three pole (160 to 200 amps) |

| 3 Third Decision | |
|------------------------|--|
| Internal Configuration | |
| -1 | Series |
| -1REC4 | Series with auxiliary switch .110 quick connect |
| -1REG4 | Series, aux switch (gold contacts) .110 quick connect |
| -1RLS4 | Series with alarm aux switch .110 quick connect, mid-trip only |
| -1RLSG4 | Series, alarm aux switch (gold contacts), .110 quick connect, mid-trip only |
| -1RS4 | Series with alarm aux switch .110 quick connect |
| -1REC5 | Series with aux switch .187 quick connect |
| -1RLS5 | Series with alarm aux switch .187 quick connect, mid-trip only |
| -1RS4 | Series with alarm aux switch .187 quick connect |
| -1RS5 | Series with alarm aux switch .187 quick connect, mid-trip |

| 4 Fourth Decision | |
|---------------------|---------------------------------------|
| Frequency and Delay | |
| -51 | DC 125% short delay (125 to 150 amp) |
| | DC 135% short delay (160 to 200 amp) |
| -52 | DC 125% long delay (125 to 150 amp) |
| | DC 135% long delay (160 to 200 amp) |
| -59 | DC 125% instant trip (125 to 150 amp) |
| | DC 135% instant trip (160 to 200 amp) |

For addition of inertial delay, add an "F" to any delay option. Example: -59 becomes -59F

| 5 Fifth Decision | |
|----------------------|------|
| Rated Current (Amps) | |
| | 125. |
| | 130. |
| | 135. |
| | 150. |
| | 175. |
| | 200. |

Additional ratings available.

| 6 Sixth Decision | |
|--|--|
| Optional (leave entry blank if none apply) | |
| -A | Metric thread mounting inserts and terminals |
| -G | Snap-in mounting plate adapter with handle guard (ZX, BX & snap-in only) |
| -X | Handle guard with no actuate off feature (BX only, no mid-trip) |
| -P | Snap-in mounting plate adapter |

Notes:
1. One or more descriptions may be used as required.
2. When this decision is not used, decision 7 may be substituted and U.S. thread will be supplied.

V = VDE Approved

The shaded areas denote VDE approval options. This approval requires the addition of a V at the end of the part number. The V will be added to any part number formed entirely from shaded decisions. If non-shaded areas are selected, the unit will not be VDE approved, but other approvals still apply.

Example:

LELHPK 11 - 1REC4 - 51 - 125. - A - 01 - V

1 2 3 4 5 6 7

| 7 Seventh Decision | |
|---------------------|--------------------------|
| Toggle Handle Color | |
| -01 | Black w/ white markings |
| -11 | Yellow w/ black markings |
| -21 | Red w/ white markings |
| -31 | Blue w/ white markings |
| -41 | Green w/ white markings |
| -61 | Orange w/ black markings |
| -91 | White w/ black markings |

See LEL alternative 7th decision for ZX & BX rocker handles

CELHP DECISION TABLES

| 1 First Decision | | Terminal | |
|------------------|---|----------|--|
| Select Type | | | |
| CELP | One toggle handle per unit | | Standard screw terminal, no designation required |
| CELHP | One toggle handle per pole | K | Stud terminals |
| CMLHP | One toggle handle per pole, mid-trip construction | C | Clip terminals |
| CELZXP | One rocker handle per unit | B | Bullet terminals |
| CELBXP | One flat rocker handle per unit | | |

1. One toggle handle per unit is available only on 101A to 200A (two parallel pole construction)
 2. 201A to 250A (three parallel pole constructions) require handles in each pole, "H" version first decision
 3. Unit supplied with bullet terminals will not have buss bar installed, unless requested, buss bar supplied standard to 150A only.
 4. One handle per unit is available for 100A to 200A (two parallel pole constructions) and 201A to 250A (three pole constructions) (ZX & BX versions only)
 5. 400 amps available with toggle handles only

V = VDE Approved

The shaded areas denote VDE approval options. This approval requires the addition of a V at the end of the part number. The V will be added to any part number formed entirely from shaded decisions. If non-shaded areas are selected, the unit will not be VDE approved, but other approvals still apply.

Example:

CELHPK 11 - 1REC4 - 51 - 125. - A - 01 - V

1 2 3 4 5 6 7

| 2 Second Decision | |
|-------------------|------------------------------|
| Poles | |
| 11 | Two pole (up to 150 amps) |
| 111 | Three pole (160 to 250 amps) |
| 1111 | Four pole (400 amps) |

| 3 Third Decision | |
|------------------------|---|
| Internal Configuration | |
| -0 | Switch only |
| -1 | Series |
| -1REC4 | Series with auxiliary switch .110 quick connect |
| -1RLS4 * | Series with alarm aux. switch .110 quick connect, mid-trip only |
| -1RS4 * | Series with alarm aux. switch .110 quick connect |
| -1REC5 | Series with auxiliary switch .187 quick connect |
| -1RLS5 * | Series with alarm aux. switch .187 quick connect, mid-trip only |
| -1RS4 * | Series with alarm aux. switch .187 quick connect |

1. Only one auxiliary switch is normally supplied on two and three pole units. Switch is located in the right hand pole (viewed from terminal end panel mount position).
 2. When more than one aux. switch is required, change the 1 (of the 1REC4) to 2 or 3. If switches are mixed, then use "2R" or 3R"
 * Not available at 400 amps

| 4 Fourth Decision | |
|---------------------|---------------------------------------|
| Frequency and Delay | |
| -51 | DC 125% short delay (101 to 150 amp) |
| | DC 135% short delay (160 to 250 amp) |
| -52 | DC 125% long delay (101 to 150 amp) |
| | DC 135% long delay (160 to 250 amp) |
| -53 | DC 125% motor start (101 to 150 amp) |
| | DC 135% motor start (160 to 250 amp) |
| -59 | DC 125% instant trip (101 to 150 amp) |
| | DC 135% instant trip (160 to 250 amp) |

| 5 Fifth Decision | |
|-------------------------------|------|
| Rated Current (Amps) | |
| | 125. |
| | 130. |
| | 135. |
| | 150. |
| | 175. |
| | 200. |
| | 400. |
| Additional ratings available. | |

| 7 Seventh Decision | |
|---|--------------------------|
| Toggle Handle Color | |
| -01 | Black w/ white markings |
| -11 | Yellow w/ black markings |
| -21 | Red w/ white markings |
| -31 | Blue w/ white markings |
| -41 | Green w/ white markings |
| -61 | Orange w/ black markings |
| -91 | White w/ black markings |
| See LEL alternative 7th decision for ZX & BX rocker handles | |

| 6 Sixth Decision | |
|--|--|
| Optional (leave entry blank if none apply) | |
| -A | Metric thread mounting inserts and terminals |
| -B | Barrier |
| -G | Snap-in mounting plate adapter with handle guard (ZX, BX & snap-in only) |
| -X | Handle guard with no actuate off feature (BX only, no mid-trip) |
| -1 | Silver 5/16" (.312") bullet |
| -2 | Gold 5/16" (.312") bullet |

Notes:
 1. One or more descriptions may be used as required.
 2. When this decision is not used, decision 7 may be substituted and U.S. thread will be supplied

