



NEW expanded product line



Military Knobs

KNOBS, HARDWARE AND MECHANICAL DEVICES

Military Knobs index



MS91528 SERIES KNOBS [PAGES 2M through 3M](#)



MS91528 SERIES CONCENTRIC KNOBS [PAGE 4M](#)



MS91528 TACTILE-SHAPED TOPS [PAGE 5M](#)



MIL-K-3926 NONILLUMINATED KNOBS [PAGE 6M](#)



MS90120 NONILLUMINATED KNOBS [PAGE 7M](#)



SPECIAL KNOBS [PAGE 8M](#)



MS SERIES AIRCRAFT CONTROL HANDLES [PAGE 9M](#)



NAS SERIES AIRCRAFT CONTROL HANDLES [PAGE 10M](#)



NAS 1553 SERIES- CASTED CLAMP KNOBS PAGE 11M



MS91524 THROUGH MS91525- CASTED KNOBS PAGES 12M and 13M



CASTED AND MACHINED METAL KNOBS PAGE 14M



MECHANICAL DEVICES PAGES 16M through 20M



HARDWARE PAGES 22M and 23M

MILITARY REQUIREMENTS PAGE 24M

TECHNICAL DATA PAGE 25M

MECHANICAL TOLERANCES PAGE 26M

INDEX BY STYLE NO. PAGE 27M

ISO 9001
certified



Visit Our website at
www.ehcknobs.com

Email: sales@ehcknobs.com

MANUFACTURER OF MAN/MACHINE INTERFACE COMPONENTS.

CALL FOR FREE SAMPLES
800.752.1680 OR FAX 631.752.1971



ROUND

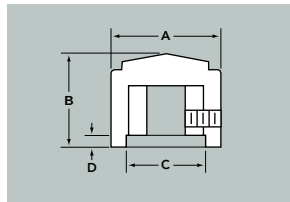

Part Number		NUT CLEARANCE				TO COMPLETE PART NUMBER			
MS91528 Plain Top	White Dot	A Diam.	B Height	C Diam.	D Depth	Style	Shaft Hole	Color	Suffix
0N	0C	.500	.510	.435	.026	N	1	B	-
1N	1C	.700	.610	.485	.026	C	2	S	
2N	2C	.900	.790	.640	.114		3	G	
3N	3C	1.250	.700	.750	.114		4	J	
4N	4C	1.750	.850	.750	.114				
5N	5C	2.250	.875	.750	.114				



SKIRTED ROUND

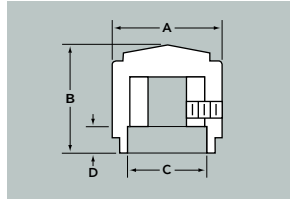

Part Number		NUT CLEARANCE				TO COMPLETE PART NUMBER			
MS91528 Plain Top	White Dot	A Diam.	B Height	C Diam.	D Depth	Style	Shaft Hole	Color	Suffix
0D	0E	.500	.655	.300	.177	D	1	B	-
1D	1E	.700	.782	.485	.188	E	2	S	
2D	2E	.900	1.010	.640	.320		3	G	
3D	3E	1.250	.850	.750	.250		4	J	
4D	4E	1.750	1.070	.750	.320				
5D	5E	2.250	1.095	.750	.320				



DIAL

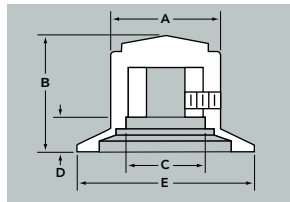

Part Number		NUT CLEARANCE					TO COMPLETE PART NUMBER			
MS91528 Plain Top with Arrow Dial	White Dot	A Diam.	B Height	C Diam.	D Depth	E Width	Style	Shaft Hole	Color	Suffix
0F	0G	.500	.655	.300	.177	.900	F	1	B	-
1F	1G	.700	.782	.485	.188	1.150	G	2	S	
2F	2G	.900	1.010	.640	.320	1.500		3	G	
3F	3G	1.250	.850	.750	.250	1.837		4	J	
4F	4G	1.750	1.070	.750	.320	2.468				
5F	5G	2.250	1.095	.750	.320	3.020				



POINTER

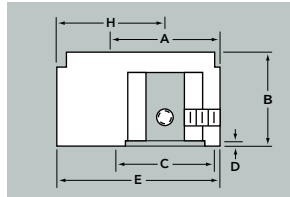

Part Number		NUT CLEARANCE					TO COMPLETE PART NUMBER				
MS91528	White Dot	A Diam.	B Height	C Diam.	D Depth	E Length	H Swing	Style	Shaft Hole	Color	Suffix
0P		.500	.510	.420	.026	.740	.490	P	1	B	-
1P		.700	.610	.485	.026	1.030	.680		2	S	
2P		.900	.790	.640	.114	1.335	.885		3	G	
									4	J	



SKIRTED POINTER

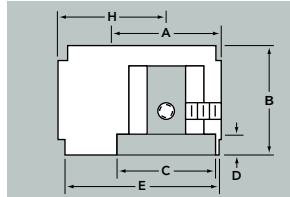

Part Number		NUT CLEARANCE					TO COMPLETE PART NUMBER				
MS91528	White Dot	A Diam.	B Height	C Diam.	D Depth	E Length	H Swing	Style	Shaft Hole	Color	Suffix
0K		.500	.655	.300	.177	.740	.490	K	1	B	-
1K		.700	.782	.485	.188	1.030	.680		2	S	
2K		.900	1.010	.640	.320	1.335	.885		3	G	
									4	J	



DOUBLE BAR

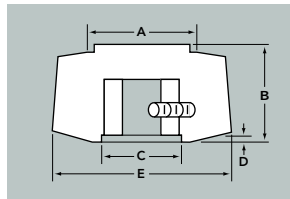

Part Number		NUT CLEARANCE				TO COMPLETE PART NUMBER				
MS91528	White Dot	A Diam.	B Height	C Diam.	D Depth	E Width	Style	Shaft Hole	Color	Suffix
1GG		.700	.610	.485	.026	1.150	GG	1	B	-
								2	G	
								3		
								4		



SKIRTED DOUBLE BAR

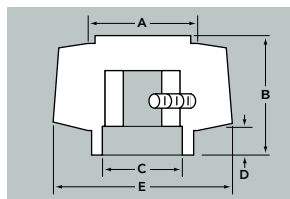

Part Number		NUT CLEARANCE				TO COMPLETE PART NUMBER				
MS91528	White Dot	A Diam.	B Height	C Diam.	D Depth	E Width	Style	Shaft Hole	Color	Suffix
1HH		.700	.782	.485	.188	1.150	HH	1	B	-
								2	G	
								3		
								4		



DOUBLE BAR W/DIAL

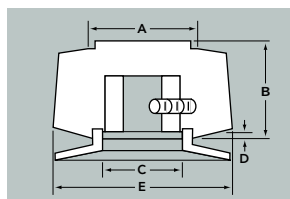

Part Number		NUT CLEARANCE				TO COMPLETE PART NUMBER				
MS91528	White Dot	A Diam.	B Height	C Diam.	D Depth	E Width	Style	Shaft Hole	Color	Suffix
1II		.700	.782	.485	.188	1.150	II	1	B	-
								2	G	
								3		
								4		

REFER TO ORDERING GUIDE ON PAGE 5M FOR STYLE, SHAFT HOLE SPECIFICATIONS AND COLORS.



BAR

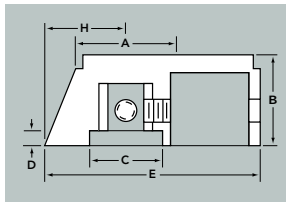

Part Number	NUT CLEARANCE		TO COMPLETE PART NUMBER							
	A Diam.	B Height	C Diam.	D Depth	E Length	H Swing	Style	Shaft Hole	Color	Suffix
MS91528							A	2	B	-
1A__	.700	.645	.515	.110	1.515	.575		4	S	
								G	J	



BAR W/DIAL

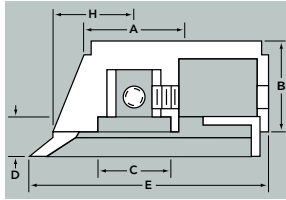

Part Number	NUT CLEARANCE		TO COMPLETE PART NUMBER							
	A Diam.	B Height	C Diam.	D Depth	E Length	H Swing	Style	Shaft Hole	Color	Suffix
MS91528							B	2	B	-
1B__	.700	.815	.515	.266	1.720	.780		4	S	
								G	J	



ANTI-PARALLAX BAR

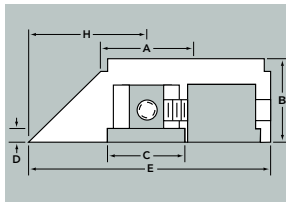

Part Number	NUT CLEARANCE		TO COMPLETE PART NUMBER							
	A Diam.	B Height	C Diam.	D Depth	E Length	H Swing	Style	Shaft Hole	Color	Suffix
MS91528							L	2	B	-
2L__	.700	.645	.595	.110	1.855	.900		4	S	
								G	J	



ANTI-PARALLAX BAR W/DIAL

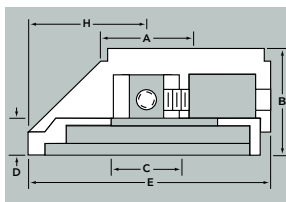

Part Number	NUT CLEARANCE		TO COMPLETE PART NUMBER							
	A Diam.	B Height	C Diam.	D Depth	E Length	H Swing	Style	Shaft Hole	Color	Suffix
MS91528							M	2	B	-
2M__	.700	.815	.470	.266	1.870	.915		4	S	
								G	J	



LONG BAR

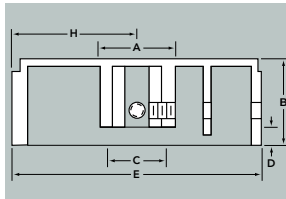

Part Number	NUT CLEARANCE		TO COMPLETE PART NUMBER							
	A Diam.	B Height	C Diam.	D Depth	E Length	H Swing	Style	Shaft Hole	Color	Suffix
MS91528							R	2	B	-
3R__	.788	.869	.562	.177	2.552	1.290		4	S	
								G	J	



SPINNER

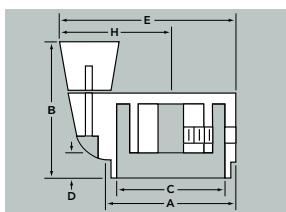

Part Number	NUT CLEARANCE		TO COMPLETE PART NUMBER							
	A Diam.	B Height	C Diam.	D Depth	E Width	H Swing	Style	Shaft Hole	Color	Suffix
MS91528							S	2	B	-
3S__	1.250	1.350	.685	.250	1.715	1.090		4	S	
4S__	1.750	1.758	.685	.320	2.359	1.484			G	
5S__	2.250	1.782	.685	.320	2.859	1.734			J	



KNOB LOCK POINTER

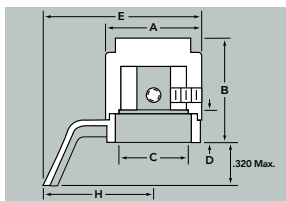

Part Number	NUT CLEARANCE		TO COMPLETE PART NUMBER							
	A Diam.	B Height	C Diam.	D Depth	E Width	H Swing	Style	Shaft Hole	Color	Suffix
MS91528							AA	1	B	-
1AA__	.700	.782	.560	.188	1.162	.812		2	S	
2AA__	.900	.958	.640	.188	1.418	.968		3	G	
3AA__	1.250	.862	.750	.188	1.750	1.125		4	J	



KNOB LOCK

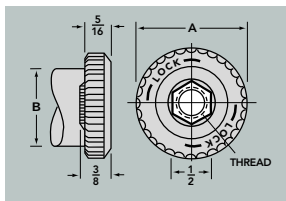

Part Number	NUT CLEARANCE		TO COMPLETE PART NUMBER				
	Splash Proof	A Diam.	B* Diam.	Style	Shaft Hole	Color	Suffix
MS91528							
1CC__	1DD__	1.030	.721	CC	1	B	-
2CC__	2DD__	1.340	.928	DD	2	S	
3CC__	3DD__	2.250	1.269			G	
						J	

THREAD SIZE: 1— 1/4—32
2— 3/8—32
*Maximum knob diameter with which a knob lock will function as a lock.

See our mechanical section on page 20M for details on our (KS series) locking mechanism.

MILITARY SERIES

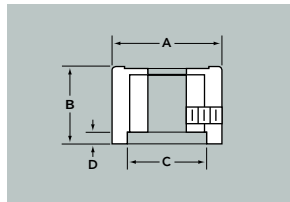
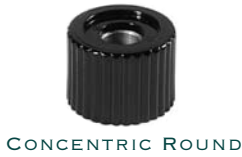

Part Number	NUT CLEARANCE				TO COMPLETE PART NUMBER			
	A Diam.	B Height	C Diam.	D Depth	Style	Shaft Hole	Color	Suffix
MS91528 1N__C	.700	.510	.485	.026	N	2	B	C
2N__C	.900	.655	.640	.114		4	S	
3N__C	1.250	.530	.750	.114			G J	

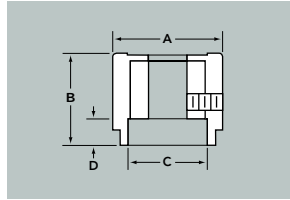

Part Number	NUT CLEARANCE				TO COMPLETE PART NUMBER			
	A Diam.	B Height	C Diam.	D Depth	Style	Shaft Hole	Color	Suffix
MS91528 1D__C	.700	.690	.485	.188	D	2	B	C
2D__C	.900	.885	.640	.320		4	S	
3D__C	1.250	.700	.750	.250			G J	

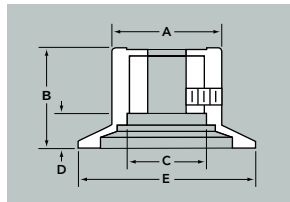
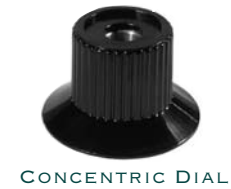

Part Number	With Arrow	MS91528 Plain Dial	NUT CLEARANCE				TO COMPLETE PART NUMBER				
			A Diam.	B Height	C Diam.	D Depth	E Width	Style	Shaft Hole	Color	Suffix
1G__C		1F__C	.700	.690	.485	.188	1.150	G	2	B	C
2G__C		2F__C	.900	.885	.640	.320	1.500	F	4	S	
3G__C		3F__C	1.250	.700	.750	.250	1.837			G J	

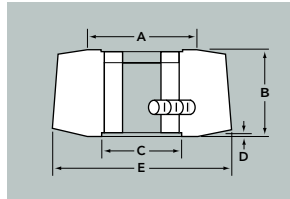

Part Number	NUT CLEARANCE					TO COMPLETE PART NUMBER			
	A Diam.	B Height	C Diam.	D Depth	E Width	Style	Shaft Hole	Color	Suffix
MS91528 1GG__C	.700	.510	.485	.026	1.150	GG	2	B	C
						JJ	4	S	
						SS		G J	

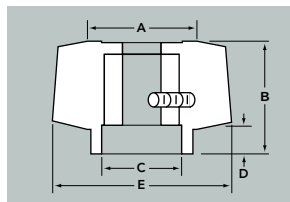

Part Number	NUT CLEARANCE					TO COMPLETE PART NUMBER			
	A Diam.	B Height	C Diam.	D Depth	E Width	Style	Shaft Hole	Color	Suffix
MS91528 1HH__C	.700	.690	.485	.188	1.150	HH	2	B	C
							4	S	
								G J	

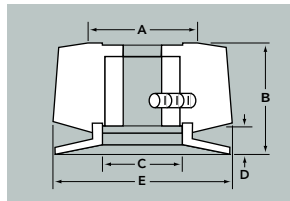

Part Number	NUT CLEARANCE					TO COMPLETE PART NUMBER			
	A Diam.	B Height	C Diam.	D Depth	E Width	Style	Shaft Hole	Color	Suffix
MS91528 1II__C	.700	.690	.485	.188	1.150	II	2	B	C
							4	S	
								G J	

REFER TO ORDERING GUIDE ON PAGE 5M FOR STYLE, SHAFT HOLE SPECIFICATIONS AND COLORS.

KNOB LOCKS

See our mechanical section on page 20M for details on our (KL series) locking mechanism.



STYLE KL701
.70 DIAM. KNOB



STYLE KL901
.90 DIAM. KNOB



STYLE KL1251
1.25 DIAM. KNOB



STYLE KL701
.70 DIAMETER
KNOB LOCK
POINTER



STYLE KL901
.90 DIAMETER
KNOB LOCK
POINTER



STYLE KL1251
1.25 DIAMETER
KNOB LOCK
POINTER

TACTILE SHAPES These tactile-shaped and colored tops can be combined with all knob styles except bar pointer. Available in Black or Gray with colored top; Matte finish.

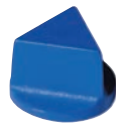

FORM 1
INTENSITY
BLUE



FORM 2
TUNE
ORANGE



FORM 3
DIMMER
WHITE

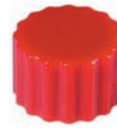

FORM 4
GAIN
RED



FORM 5
FOCUS
VIOLET



FORM 6
RANGE
YELLOW



FORM 7
RANGE
YELLOW

Standard Tactile Cap	Diameter	Round	Skirted Round	Dial	Pointer	Skirted Pointer
FORM 1 Intensity-Blue	70	1N__1	1D__1	1F__1	-	-
	90	2N__1	2D__1	2F__1	-	-
	125	3N__1	3D__1	3F__1	-	-
FORM 2 Tune-Orange	70	1N__2	1D__2	1F__2	-	-
	90	2N__2	2D__2	2F__2	-	-
	125	3N__2	3D__2	3F__2	-	-
FORM 3 Dimmer-White	70	1N__3	1D__3	1F__3	-	-
	90	2N__3	2D__3	2F__3	-	-
	125	3N__3	3D__3	3F__3	-	-
FORM 4 Gain-Red	70	1N__4	1D__4	1F__4	-	-
	90	2N__4	2D__4	2F__4	-	-
	125	3N__4	3D__4	3F__4	-	-
FORM 5 Focus-Violet	70	1N__5	1D__5	1F__5	-	-
	90	2N__5	2D__5	2F__5	-	-
	125	3N__5	3D__5	3F__5	-	-
FORM 6 (ROUND) Range-Yellow	70	1N__6	1D__6	1F__6	-	-
	90	2N__6	2D__6	2F__6	-	-
	125	3N__6	3D__6	3F__6	-	-
FORM 7 (POINTER) Range-Yellow	70	-	-	-	1P__7	1K__7
	90	-	-	-	2P__7	2K__7

SPINNER HANDLES



FORM 8
MARKER
GREEN



FORM 9
BEARING
GRAY

Standard Tactile Cap	Series	Crank
FORM 8 Marker-Green	125	3S__8
	175	4S__8
	225	5S__8
FORM 9 Bearing-Gray	125	3S__9
	175	4S__9
	225	5S__9

ORDERING GUIDE FOR MILITARY SERIES

Cap Design	Diam.	Style		Shaft Hole	Color	Suffix
Indicate Part No. from Tables Above	0 = .500	N- Round	A- Bar	1- 1/8" Round	B- Matte Black	C= Concentric Tactiles:
	1 = .700	D- Skirted Round	B- Bar w/Dial	2- 1/4" Round	S- Gloss Black	1- Blue
	2 = .900	F- Dial	L- Anti-Parallax Bar	3- 3/8" "D" Hole	G- Matte Gray	2- Orange
	3 = 1.250	P- Pointer	M- Anti-Parallax Bar w/Dial	4- 1/2" "D" Hole	J- Gloss Gray	3- White
	4 = 1.750	K- Skirted Ptr.	GG- Dbl. Bar	5- .190 Round		4- Red
5 = 2.250	II- Skt. Dbl. Bar w/Dial	R- Long Bar	6- .267 Round		5- Violet	
		HH- Skt. Dbl. Bar w/Dial	S- Spinner			6- Yellow
						7- Yellow
						8- Green
						9- Grey

SET SCREW SPECIFICATIONS

Each Knob Furnished with (2) Set Screws

Series	1/8" Shaft Hole	1/4" Shaft Hole
0	4-40 UNC-3A	4-40 UNC-3A
1	4-40 UNC-3A	4-40 UNC-3A
2	4-40 UNC-3A	8-32 UNC-3A
3		8-32 UNC-3A
4		8-32 UNC-3A

TOLERANCES

A	B	C	D	E
+ .030	± .030	Min.	Min.	Max.

EXAMPLE: MS91528-1N2B2

	Diameter	Style	Shaft Hole	Color	Suffix
	.700	Round	.250"	Matte Black	Tactile Top
91528-	1	N	2	B	2

NONILLUMINATED MIL KNOBS

IN ACCORDANCE WITH MIL-K-3926

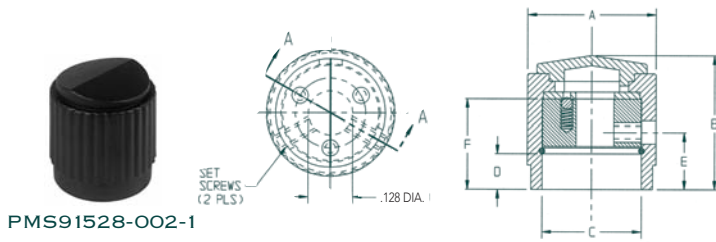

PMS91528-002-1

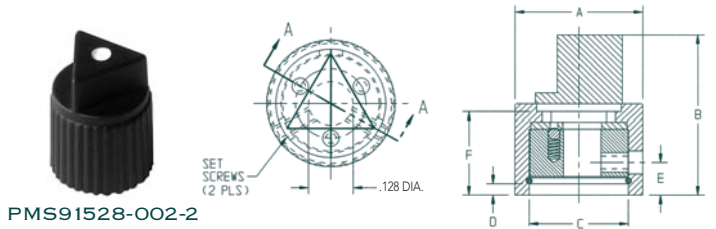

PMS91528-002-2

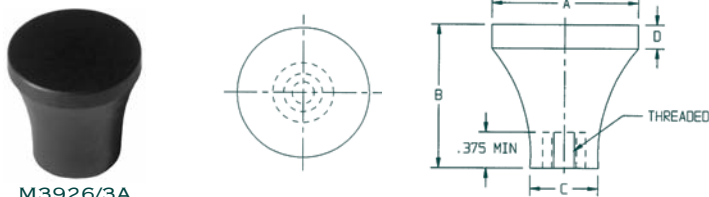

M3926/3A

Series Number

	A Base Diam.	B Height	C Diam. Nut Clearance	D Height Nut Clearance	E	F
1	0.500	0.655	0.300	0.177	.0325	0.470
2	0.500	0.793	0.359	0.026	.0158	0.560

Knob clutch and slip torque.
Range 11-24 inch-ounces

Series Number

	A Diameter ±.016	B Height ±.031	C ±.016	D ±.016
0	0.750	0.750	0.500	0.094
2	1.000	1.000	0.562	0.125
4	1.500	1.500	0.688	0.250

Knob, control, tapered

ORDERING GUIDE FOR MIL-K 3926 SERIES

Series	Thread		Material 1 Plastic	Material 2 Plastic w/insert	Color
	UNC-2B	UNF-2B			
0	A-.1640-32	B-.1900-32	A,B	-	B- Black
2	E-.2500-20	C-.2500-28	A,B,C,D,E	A,B,C,E	R- Red
4	F-.3125-18	D-.3750-24	C,D,E,F,G	C,D,E,F,G	G- Gray
	G-.3750-16				O- Olive Drab
	H-.4375-14				

EXAMPLE: M3926/3-3B2B

	Series	Thread	Material	Color
	.750	.1900-32		
M3926/3-	3	B	2	B

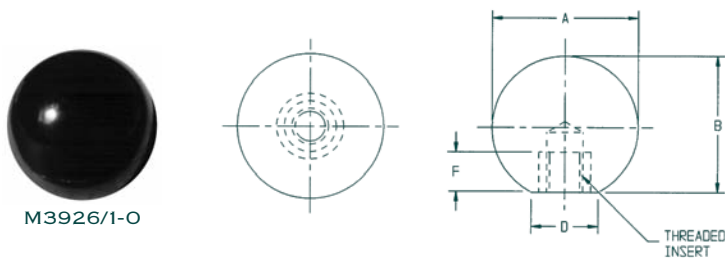

M3926/1-0

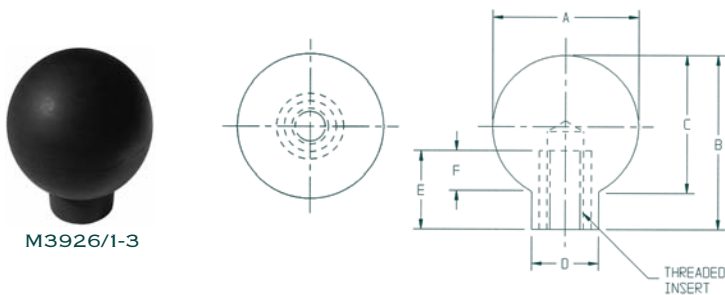

M3926/1-3

Series Number

	A ±.016	B ±.031	C ±.016	D ±.016	E	F
0	3/4	-	45/64	-	-	7/16
3	1-1/2	1-13/16	-	11/16	13/16	-

Knob, control, ball

ORDERING GUIDE FOR MIL-K 3926 SERIES

Series	Thread		Material	Color
	UNC-2B	UNF-2B		
0	A-.1640-32	B-.1900-32	1- Plastic	B- Black
3	E-.2500-20	C-.2500-28	2- Plastic w/insert	R- Red
	F-.3125-18	D-.3750-24		G- Gray
	G-.3750-16			O- Olive Drab
	H-.4375-14			

EXAMPLE: M3926/1-0A1B

	Series	Thread	Material	Color
	.700	.1640-32		
M3926/1-	0	A	1	B



NONILLUMINATED MIL KNOBS

IN ACCORDANCE WITH MS90120



MS90120-1

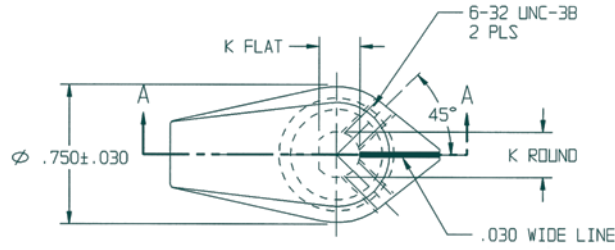

MS90120-2

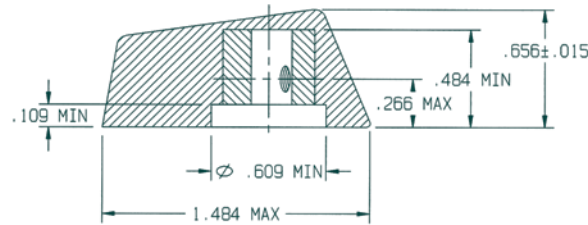

MS90120

Size	A ±0.030	Nut Clearance		D Max.	Shaft Hole Depth E Min.	F ±0.015	H Max.	M Max.	Set Screws (2) 1/4" Shaft Hole
		B Min.	C Min.						
1	0.750	0.609	0.109	0.66	0.484	0.750	0.766	2.328	6-32UNC-2A
2	0.750	0.609	0.109	0.66	0.484	0.656	0.578	1.484	6-32UNC-2A

Notes

- Material: Plastic to meet requirements of MIL-K-3926.
- Color: Black lusterless #37038 per Federal Standard 595.
Gray lusterless #36231 per Federal Standard 595.
White line- White lusterless #37038 per Federal Standard 595.
Phosphorescent line to conform to MIL-K-3891,
TT-P-54, Type 1 color green to yellow green.
- All dimensions in inches, tolerances shown.
- For design feature purposes, this standard takes precedence over procurement documents referenced herein.

ORDERING GUIDE FOR MILITARY SERIES

Size	Color	Style	Shaft Hole Diameter
1	B-Black	01- Bar w/White Line	None- 1/4"
2	G-Gray	02- Bar w/Phosphorescent Line	D- 1/4" "D" Flat

EXAMPLE: MS90120-1 G 01 D

	Size	Color	Style	Shaft Hole Diameter
	0.750	Gray	Bar w. White line	1/4" "D" Flat
90120-	1	G	01	D



x = outer diameter
y = height



744
x = .90
y = .91



745
x = .82
y = .76



741
x = .81
y = .76



743
x = .82
y = .72



742
x = .58
y = .77



525
x = .90
y = .91



524
x = .82
y = .76



523
x = .81
y = .76



522
x = .82
y = .72



546
x = .58
y = .77



845
x = .81
y = .53



755
x = .88
y = .49



411
x = 1.20
y = .48



AN3220
x = 1.52
y = .89



2037
x = 1.57
y = .77



484
x = .61
y = .46



485
x = .61
y = 1.41



486
x = .61
y = .86

High strength, reinforced thermoplastic resin with superior properties. A virtually infinite range of custom colors is available, expertly matched to your environment.

MS SERIES

HANDLE, CONTROL, AIRCRAFT



MS26517-2

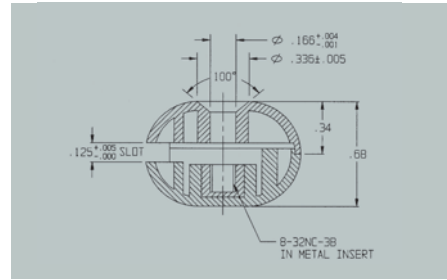
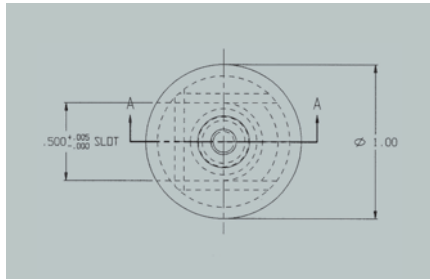

MS26518-1

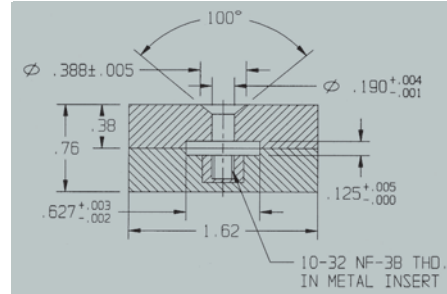
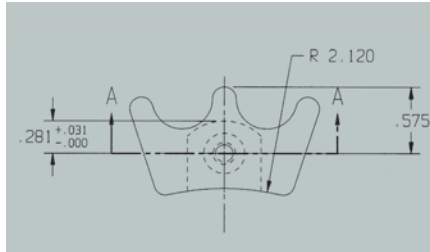

MS26519-2

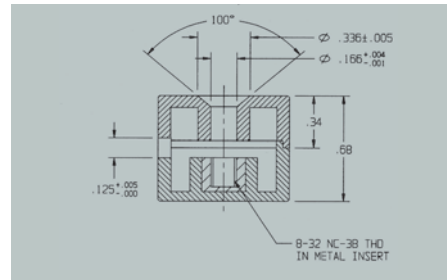
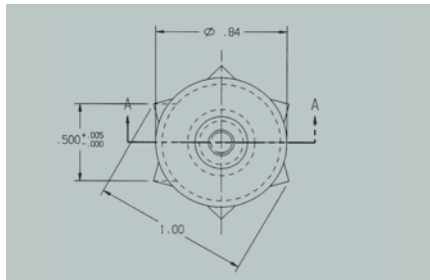

MATERIAL AND SPECIFICATION DATA

Body- Polycarbonate
 Insert- Brass ½ hard per QQ-B-626
 Color- Gray #36440/FED-STD-595

Lighted Handles- In accordance with MIL-STD-411 or MIL-C-81774
 For details see procurement specification MIL-H-8810B.

HANDLES, CONTROL, AIRCRAFT

Description	Diam. Width	MS Number
Throttle small	1.00"	MS26517-2
RPM large	1.62"	MS26518-1
Mixture small	1.00"	MS26519-2

NAS SERIES

HANDLE, CONTROL, AIRCRAFT



NAS 120

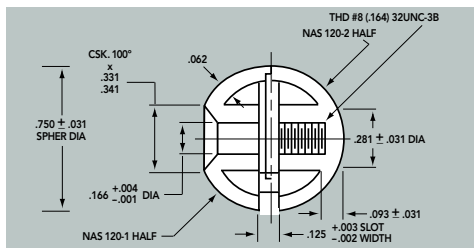

NAS 121

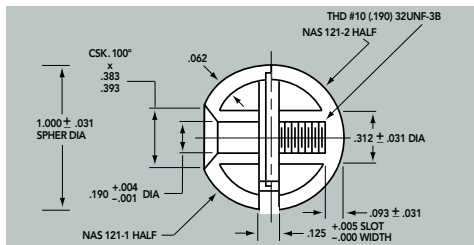

NAS 123

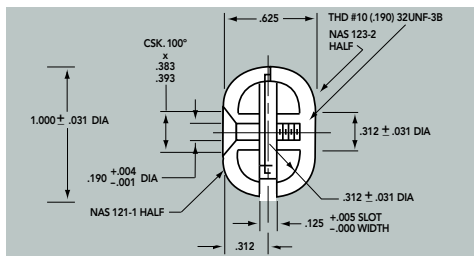

NAS 124

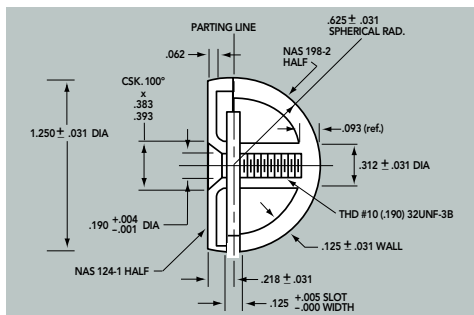

NAS 125

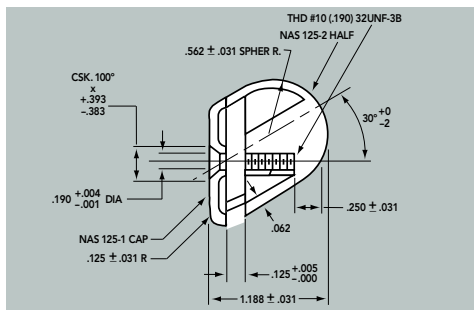

NAS 198

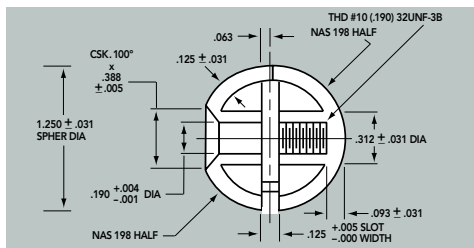

Description	Style Number
Knob Control: 3/4" Spherical	NAS 120
Knob Control: 1" Spherical	NAS 121
Knob Control: 1" x 5/8" Oval	NAS 123
Knob Control: 1 1/4" x 13/16" Horizontal	NAS 124
Knob Control: 1 1/8" x 3/16" Angular Semi-Round	NAS 125
Knob Control: 1 1/4" Spherical	NAS 198

COLORS

Color	Color Abbreviation	FED-STD-595 Color Number*
Blue	E	915
Yellow	Y	7972
Green	G	2905
Red	R	1838
Black	B	961
Light Gull Grey	L	36440
Orange	A	8567
White	W	7285
Purple	P	6075
Half Red & Half White	H	1838 (Red) 7285 (White)
Half Orange Yellow & Half Black	C	33538 (Orange Yellow) 37038 (Black)

*Tennessee Eastman Corp.

MATERIALS

Thermoplastic synthetic resin or cellulose derivative with properties similar to FED SPEC L-P-349 Type I or II class or ASTM D707 Grade H2.

FINISH

Non-specular

SLOT

.125 x .625 (exception: NAS120 is .502)

Tolerance: +.003 -.002

EXAMPLE: NAS120B125

Series	Style	Color Abbreviation	Standard Slot Width
NAS	120	Black #961	.125"

NAS _____ 125

FILL IN STYLE AND COLOR TO COMPLETE



METAL CLAMP KNOBS



NAS 1553-A
STYLE A

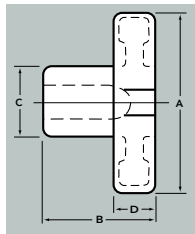

		Style A				
Style	Size	A ±.125	B ±.125	C Diam.	D	E
A	1	.750	.625	.625 .437	.313 .093	.313 .250
A	2	1.125	.750	.750 .562	.325 .125	.325 .250
A	3	1.500	1.000	1.000 .625	.438 .125	.438 .250
A	4	2.000	1.125	1.125 .750	.500 .250	.500 .250
A	5	2.500	1.500	1.750 1.250	.625 .250	.625 .250

Thread Specifications

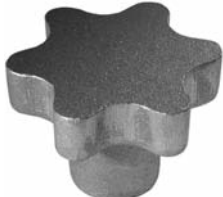
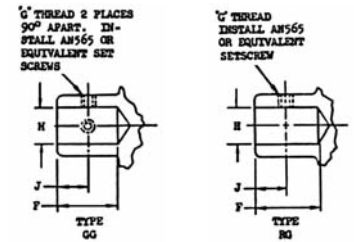

NAS 1553-B
STYLE B

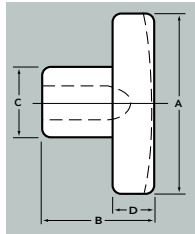

		Style B			
Style	Size	A ±.125	B ±.125	C ±.125	D ±.125
B	3	1.500	1.250	.688	.500
B	4	2.000	1.250	.875	.500
B	5	2.500	1.250	1.125	.500
B	6	3.000	1.325	1.250	.500

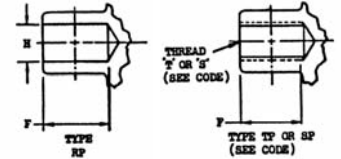

NAS 1553-C
STYLE C

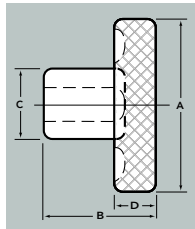

		Style C			
Style	Size	A +.125 -.000	B +.125 -.000	C +.060 -.000	D +.060 -.000
C	1	.750	.625	.500	.250
C	2	1.000	.750	.625	.250
C	3	1.500	1.000	.750	.325
C	4	2.000	1.125	.750	.325

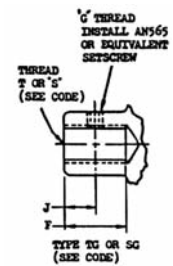

Thread Specifications

First & Second Dash No.	F Thread* +.000 -.062	G Thread Set Screw Size	H Diam.** +.0020 -.0010	J ±.032	S Thread**	T Thread**
1-3	.313	.1120-40UNC-2B	.1875	.188	.1900-32UNF-2B	.1900-24UNC-2B
2-3	.438	.1380-32UNC-2B	.1875	.218	.1900-32UNF-2B	.1900-24UNC-2B
2-4			.2500	.218	.2500-28UNF-2B	.2500-20UNC-2B
3-4	.625	.1900-32UNF-2B	.2500	.325	.2500-28UNF-2B	.2500-20UNC-2B
3-5			.3125	.325	.3125-24UNF-2B	.3125-18UNC-2B
4-5	.750	.1900-32UNF-2B	.3125	.350	.3125-24UNF-2B	.3125-18UNC-2B
4-6			.3750	.350	.3750-24UNF-2B	.3750-16UNC-2B
4-8			.5000	.350	.5000-20UNF-2B	.5000-13UNC-2B
5-8	.750	.1900-32UNF-2B	.5000	.500	.5000-20UNF-2B	.5000-13UNC-2B
5-10			.6250	.500	.6250-18UNF-2B	.6250-11UNC-2B
5-12			.7500	.500	.7500-16UNF-2B	.7500-10UNC-2B
6-10	.825	.1900-32UNF-2B	.6250	.500	.6250-18UNF-2B	.6250-11UNC-2B
6-12			.7500	.500	.7500-16UNF-2B	.7500-10UNC-2B

*or drill depth

**see code

EXAMPLE: NAS 1553-A4 D 6RP

Specification Designation	Style	Size	Material	Bore Diam.	Bore Style	Retent. Method
	1	2	3	4	5	6
NAS 1553-	A	4	D	6	R	P

Positions

Code

1) **Style:** A, B, or C (see above). For example: (Style) "A" is a 4 prong knob.

2) **Size:** 1, 2, 3, 4, 5, and 6 (see above). In chart see: (Style) "A,4" has a diameter of 2.00 inches.

3) **Material:** D, F, or M. "D" is Anodized Aluminum; "F" is Cast Iron; "M" is Cadmium plated Cast Iron with smooth bore.

NOTE: If there is no designation in position 3 (D, F, or M) then the material callout is Cadmium Plated Steel. Example: NAS1553A46RP

4) **Inside Diameter:** 3, 4, 5, 6, 8, 10, and 12 (see Thread chart). First and second numbers 6 (Position 4) equal .375 ID.

NOTE: If there is no designation in positions 4, 5, and 6 this defines an unfinished blank with no bore size or retention method but a suitable corrosion preventative. Example: NAS1553A4

5) **Bore Style:** S, T, R, and G. (see Thread chart). "S" and "T" are thread size. "G" designates two set screws; "R" one set screw.

6) **Retention Method:** G, or P. "G" is set screw size. "P" roll pin attachment method to be drilled and reamed at installation.



DIE CAST KNOBS

IN ACCORDANCE WITH MS91524-9

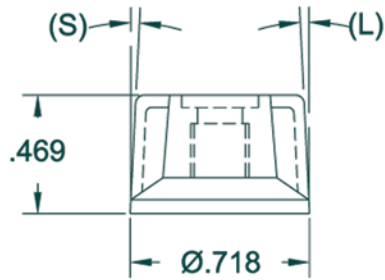
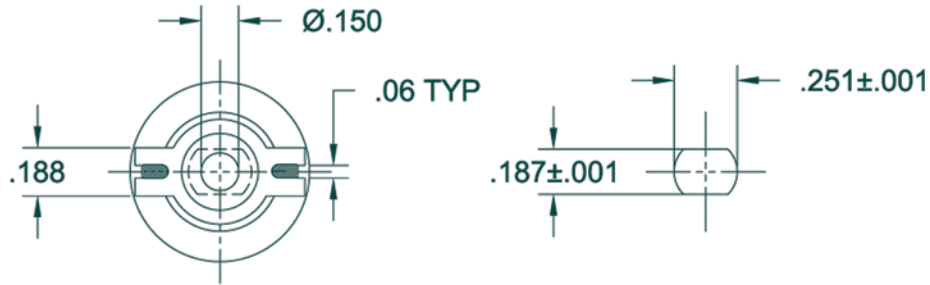

SERIES 9

DIE CAST KNOBS

MS91524 Series Number	Style	Bar Angles		Color	Grooves
		(S)	(L)		
9	AW- Alum. White Line	3=4°	S=2°	B= Black	Z= (S) Bar Only
	AP- Alum. Phosphorescent Line		T=4°	G= Gray	Y= (L) Bar Only
	AF- Alum. Flourescent Line			O= Olive Drab	X= Both Bars W= Both Bars, Top Only

For detailed information on any of the above items contact the factory.

REFER TO INDEX ON PAGE 27M FOR SIMILAR KNOBS TO USE IN PLACE OF THOSE LISTED ON THIS PAGE.

EXAMPLE: MS91524-9AW3TGX

Series	Style	Bar Angles		Color	Grooves
		(S)	(L)		
MS91524- 9	AW	3	T	G	X



DIE CAST KNOBS

IN ACCORDANCE WITH MS91525

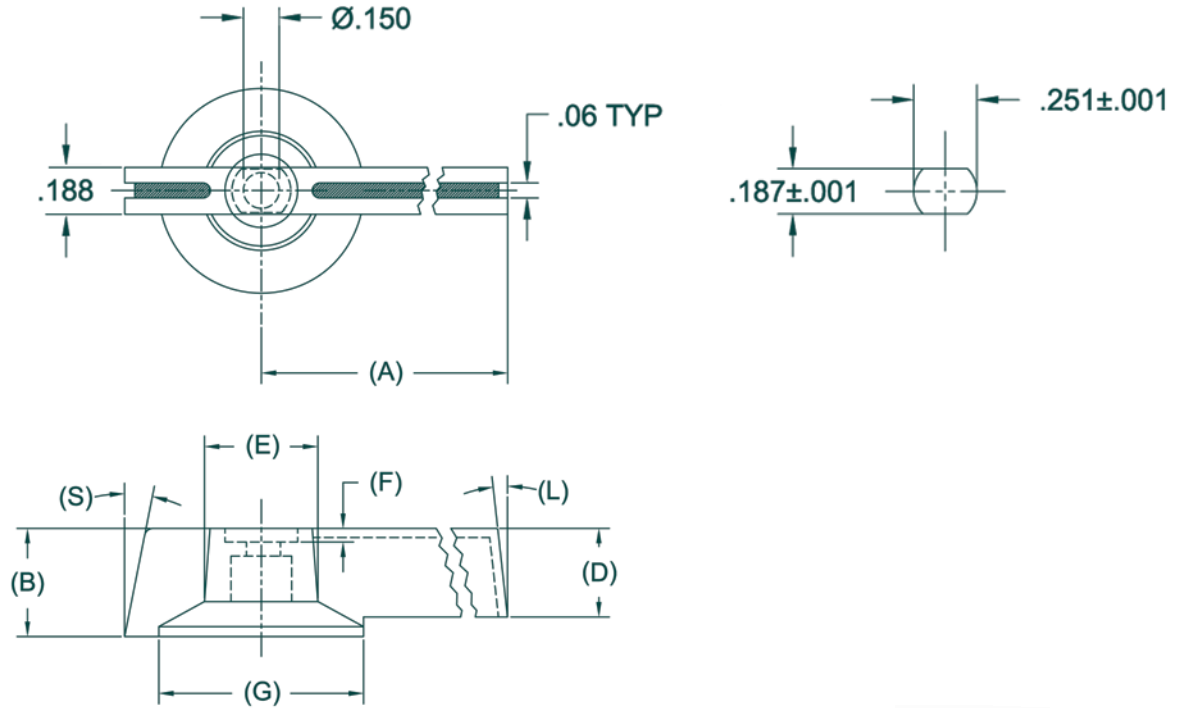

SERIES 1



SERIES 2



SERIES 3



SERIES 4



SERIES 5

DIE CAST KNOBS

MS91525 Series Number	Style	Bar Angles		Color	Grooves
		(S)	(L)		
0	AW- Alum. White Line	2=6°	S=6°	B= Black	Z= (S) Bar Only
1	AP- Alum. Phosphorescent Line	3=12°	T=12°	G= Gray	Y= (L) Bar Only
2	AF- Alum. Fluorescent Line			O= Olive Drab	X= Both Bars
3					W= Both Bars, Top Only
4					
5					

For detailed information on any of the above items contact the factory.

MS91525 Series Number	A	B	D	E	F	G
0	19/32	15/32	13/32	15/32	1/16	7/8
1	23/32	15/32	15/32	15/32	3/64	23/32
2	27/32	15/32	13/32	15/32	1/16	7/8
3	1	13/32	13/32	13/32	3/64	7/8
4	1-11/32	15/32	13/32	15/32	1/16	7/8
5	1-31/32	15/32	13/32	15/32	1/16	7/8

EXAMPLE: MS91525-1AW3TGX

REFER TO INDEX ON PAGE 27M FOR SIMILAR KNOBS TO USE IN PLACE OF THOSE LISTED ON THIS PAGE.

	Series	Style	Bar Angles		Color	Grooves
			(S)	(L)		
		Wh Line			Gray	Both Bars
MS91525-	1	AW	3	T	G	X



CAST AND MACHINED METAL KNOBS

x= outer diameter
y= height



1020
x=.58
y=.70



1328
x=.70
y=.70



2210
x=1.40
y=.96



1021
x=1.01
y=.70



810
x=.95
y=.77



812
x=1.14
y=.89



2088
x=1.12
y=.77



1022
x=.95
y=1.04



1389
x=.95
y=.85



1390
x=.58
y=.69



3300
x=1.52
y=.45



2301
x=1.23
y=.52



2012
x=.89
y=.78



817
x=1.16
y=.68



1996
x=1.22
y=.64



2013
x=1.01
y=.81



809
x=1.02
y=.55



800
x=1.26
y=.76



813
x=1.20
y=.90



801
x=.83
y=.77



1127
x=.73
y=.50



816
x=.70
y=.52



815
x=.89
y=.75



811
x=.57
y=.66



894
x=2.02
y=1.16



2201
x=1.54
y=.61



1376
x=2.19
y=1.45

MECHANICAL DEVICES

INDEX

MICRO VERNIER	16M
REDUCTION DRIVES	16M
CLUTCH KNOB	17M
PUSH-TO-TURN	18M
PUSH-TO-TURN	19M
KNOB LOCKS	20M

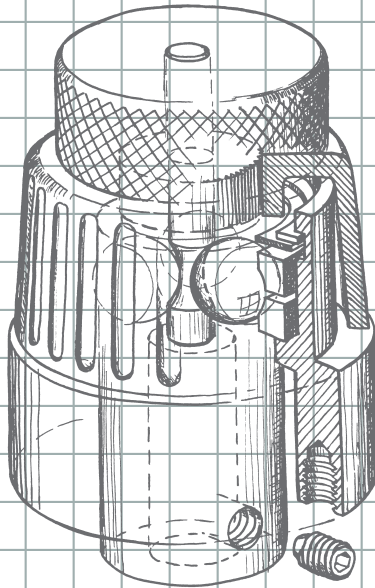

MICRO VERNIER

Provides input shaft reduction ratios for fine tuning through a zero backlash planetary friction drive mechanism offering a variety of standard ratios and mechanical interface options.

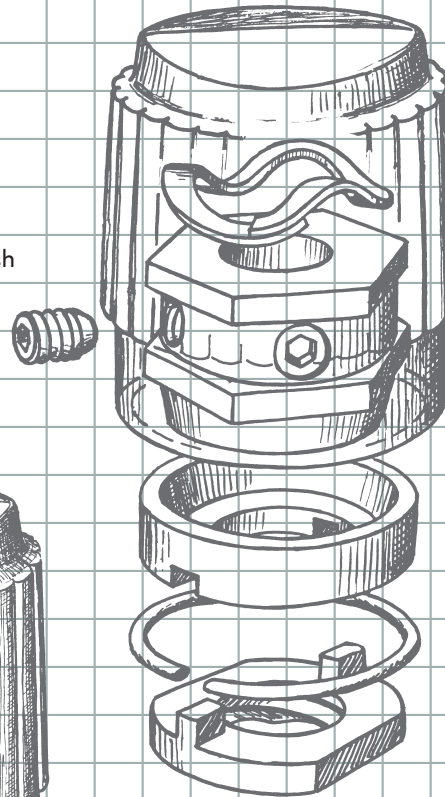

PUSH-TO-TURN

Settings remain secure against inadvertent movement, shock and vibration through a high-friction conical metallic clutch which releases cleanly when depressed and engages precisely upon release.

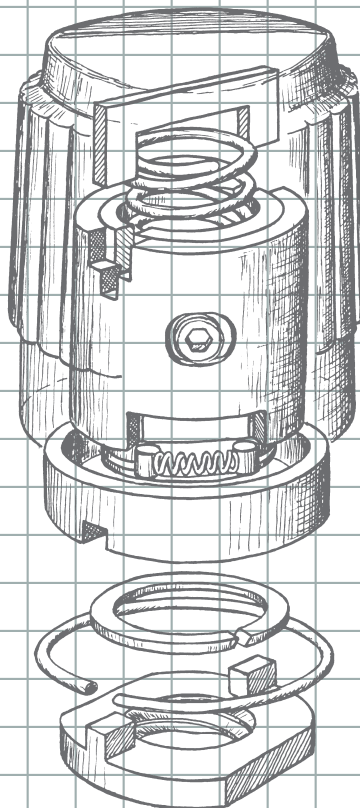

PUSH-TO-TURN

Knob design utilizes sprag type clutch mechanism offering security against shock, vibration and inadvertent change while providing ease of operation, accurate positioning and positive locking.

RATIO REDUCTION MECHANISM

MICROVERNIER REDUCTION DRIVES

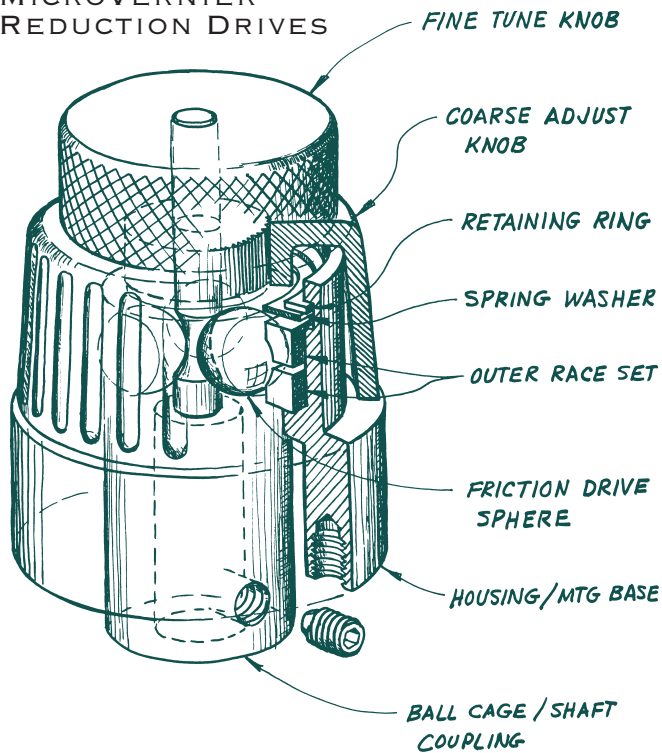

Indexing: Provides input shaft reduction ratios for fine tuning through a backlash planetary friction drive mechanism, offering a variety of standard ratios and mechanical interface options.

- Zero backlash
- Integral assembly
- Infinite resolution with absolute shaft registration
- Driving torque- 10 inch-ounces
- Saves space behind the panel
- Simple installation, no special tools required
- Knob and component shaft rotate in the same direction
- As small as 1" diameter, front or rear mounting

MicroVernier Ratio

"A" Vernier Drive	10:1 with "B" Direct Drive	1:1
"A" Vernier Drive	40:1 with "B" Direct Drive	4:1
"A" Vernier Drive	100:1 with "B" Direct Drive	10:1

Contact factory for detailed information regarding sizes, mounting, installation, and ratios, etc.

MICROVERNIER WITH LOCKING MECHANISM

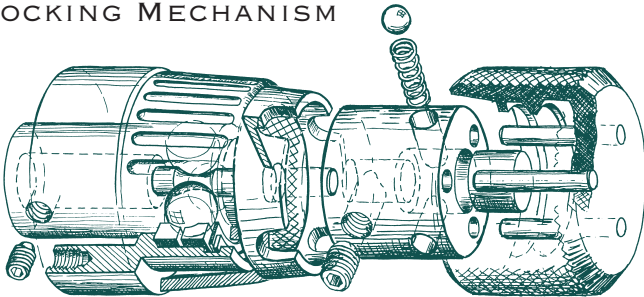

Locking MicroVernier is available with a friction lock mechanism to prevent inadvertent movement of the setting, integral to the unit.

REDUCTION DRIVE

RDL61 REDUCTION DRIVE

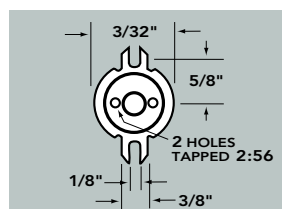
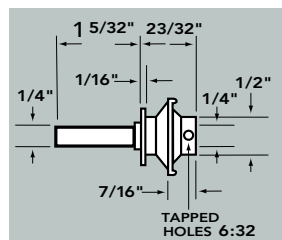
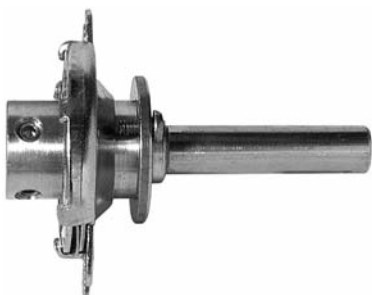

The **RDL61 Reduction Drive** is a ball drive device with a 6:1 reduction ratio.

- Dial flange is directly coupled to output shaft
- Provided with (2) 2:56 x 3/16 pan head slotted screws and (2) 6:32 x 1/8 set screws for mounting
- Working temperature range 0°C to 55°C
- Storage temperature range -40°C to 70°C
- Torque values: Output > 26 inch-oz.; Input > 3 inch-oz.

MS91528 QUALIFIED SLIP CLUTCH KNOB

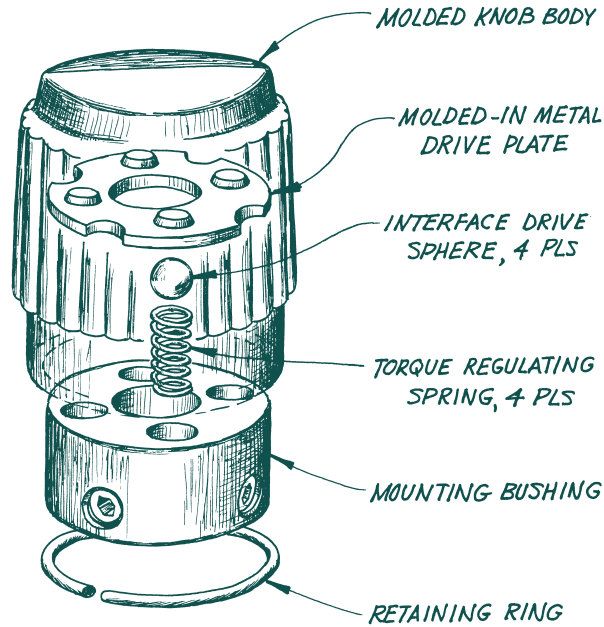

PATENT #4012966

Slip Clutch knob design utilizes a molded-in metal drive plate in conjunction with a spring loaded sphere mechanism which provides protection against over torquing and damage of the control/component.

- QPL approved for MS91528 styles
- Available sizes: .500, .700, .900, 1.250 and 1.750
- Series available: MS91528
- Available styles: Round, Pointer, Concentric, Tactile, Spinner and Bar Knobs (For dimensional information see MS91528 series, pages 2M–5M, in this catalog.)
- Clutch slip torques from:
 - 8 to 16 inch-ounces
 - 12 to 24 inch-ounces
 - 20 to 36 inch-ounces
 - 28 to 56 inch-ounces
 - 42 to 84 inch-ounces
 - 64 to 124 inch-ounces
- Slip torque based on size (diameter) of knob and style
- Special Slip Torque requirements are available
- Contact factory for information on your specific requirements

SOME OF THE STYLES AVAILABLE



ROUND



SKIRTED ROUND



CONCENTRIC



DIAL



SPINNER



CAST ALUMINUM

Contact factory for other available styles.

.700 DIAMETER
SELF LOCKING
PUSH-TO-TURN
DEVICE

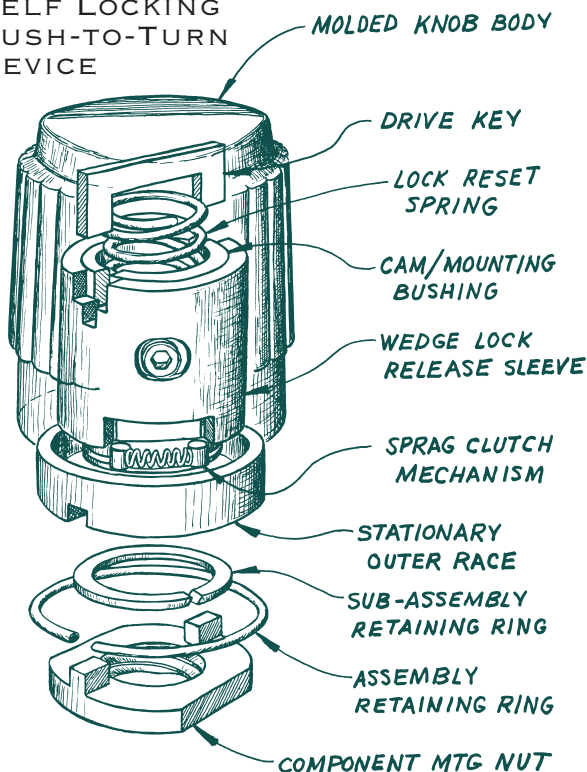

Push-to-Turn: Knob design utilizes sprag-type clutch mechanism offering security against shock, vibration and inadvertent change while providing ease of operation, accurate positioning and positive locking.

- Positive lock of control setting
- Ease of setting; one-hand operation
- Locked in the unengaged mode
- Infinite setting's locks positively on release
- Prevents movement from shock or vibration or accidental movement
- Zero backlash
- Must be fully depressed before movement
- Mounting hardware supplied with knob
- Designed for our MS91528 style series
- Engineered to meet military specifications

Part Number						TO COMPLETE PART NUMBER		
	A Diam. max.	B Height ±.030	C Shaft min.	D Set Screw	E Dial Diam. max.	Style	Shaft Hole	Finish
PT70	.730	.830	.62	.390	—	2	1	None
	.730	.950	.62	.390	1.150	3	2	G
						3NP		

ROUND
RING SKIRT

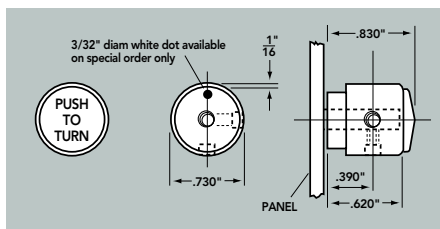

ORDERING GUIDE FOR DESIGNER SERIES

Cap Design and Diameter	Style	Shaft Hole Diameter	Finish (Black)
Indicate Part Number from Tables Above	2- Ring Skirt 3- Dial w. Arrow 3NP- Dial No Arrow	1- 1/8" Round 2- 1/4" Round	None- Gloss G- Matte

ROUND
DIAL SKIRTED

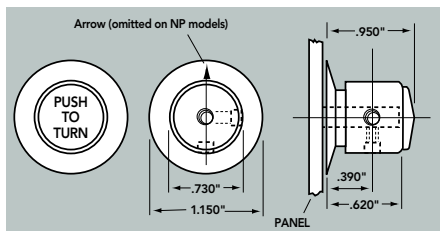

EXAMPLE: PT70-3NP-1G

Cap Design	Style	Shaft Hole	Finish
Series	Dial-No Arrow	.125"	Matte
PT70-	3NP-	1	G

INSTALLATION INSTRUCTIONS

Use the special lockwasher for mounting behind the panel and the special mounting nut with tabs for mounting in front of the panel as shown in drawing at left.*

When attaching the control knob to the shaft, engage the tabs in the tabs slot. Surface "L", in the control knob, and Surface "K", on the special mounting nut must be mounted flush against each other.

CAUTION: DO NOT REMOVE SET SCREWS. On ring skirted knobs, screws loosened out of tapped holes may fall into assembly. On dial skirted knobs, disassembled screws would allow outer shell to dis-engage from knob assembly. Loosen set screws enough to permit entry of shaft into shaft hole. Secure tightly.

Knob is now in **LOCKED** position. In order to rotate it, the knob must be fully depressed. This **UNLOCKS** it permitting free rotation of the shaft. **RELEASE** again to **LOCK**.

* If necessary, use the mounting nut of the device to be controlled as a checknut behind special lockwasher to orient threaded bushing flush with special mounting nut at Surface K.

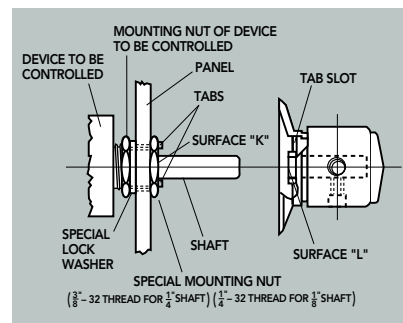

LOCKING KNOB

PUSH-TO-TURN KNOB

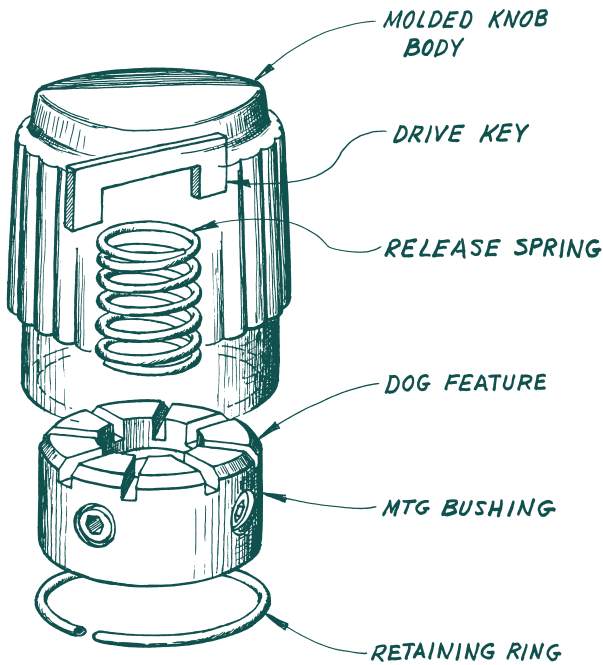

70 SERIES SELF LOCKING PUSH-TO-TURN DEVICE

Push-to-Turn: Knob turns freely until depressed. A positive dog-style coupling transmits rotary motions disengaging automatically when released.

- Resists shock, vibration, or accidental movement
- Must be fully depressed to set
- Positive locking with infinite resolutions—zero backlash
- Ease of setting; one-hand operation
- Designed for MS91528 and EH71 style knobs
- Free to rotate in unengaged mode
- Not recommended for use with calibration marking

Part Number	To COMPLETE PART NUMBER							
	A Diam.	B Height	C Shaft	D Set Screw	E Dial Diam.	Style	Shaft Hole	Finish
PTE70	.730	.830	.620	.425	—	2	1	None
	.730	.950	.620	.460	1.150	3NP	2	G

ROUND RING SKIRT

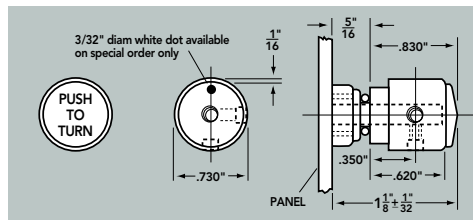

ROUND DIAL SKIRTED

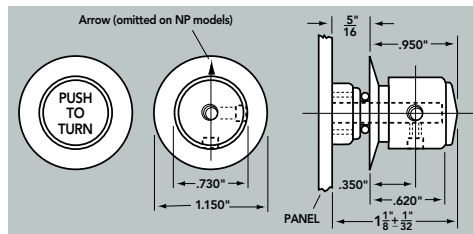

ORDERING GUIDE FOR DESIGNER SERIES

Cap Design and Diameter	Style	Shaft Hole Diameter	Finish (Black)
Indicate Part Number from Tables Above	2- Ring Skirt 3- Dial w. Pointer 3NP- Dial No Pointer	1- 1/8" Round 2- 1/4" Round	None- Gloss G- Matte

To order special colors contact our factory.

EXAMPLE: PTE70-3NP-1G

Cap Design	Style	Shaft Hole	Color
Series	Dial-No Pointer	.125"	Matte Black
PTE70-	3NP-	1	G

INSTALLATION INSTRUCTIONS

POTENTIOMETER

Remove nut supplied—it will not be required.*

Use the lockwasher supplied and make sure it is placed on the threaded portion of the shank of the potentiometer, so as to be against the back surface of the panel as the shaft is fed through the clearance hold in the panel.

Mount the shaft lock by sliding the unit down over the shaft, plastic nut portion facing the end of the shaft, so as to engage the external threaded part of the potentiometer with the internal threaded insert in the shaft lock. (Shaft lock supplied with unit.)

KNOB

Place spring, supplied, on potentiometer shaft section protruding beyond shaft lock.

Place knob on shaft and depress knob until it is seated with spring compressed. Use a #4-40 setscrew wrench (key) to tighten exposed setscrew until knob insert is firmly assembled to shaft.

Release knob to free engagement. Rotate knob 90° (ninety degrees) and depress knob to locate second setscrew. Hold knob in this position. Tighten this setscrew to complete the assembly to insert to shaft. Release knob. Unit is now properly assembled.

*When mounting special nut, it is sometimes advisable to mount the standard mounting nut behind the panel if the control's threaded bushing projects too far.

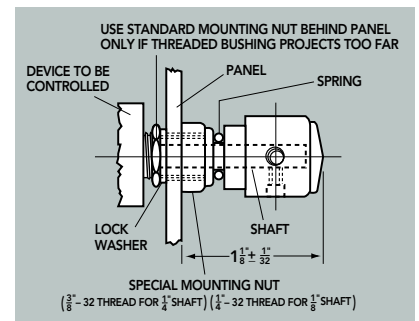

KNOB LOCKS

KNOB LOCKING DEVICES

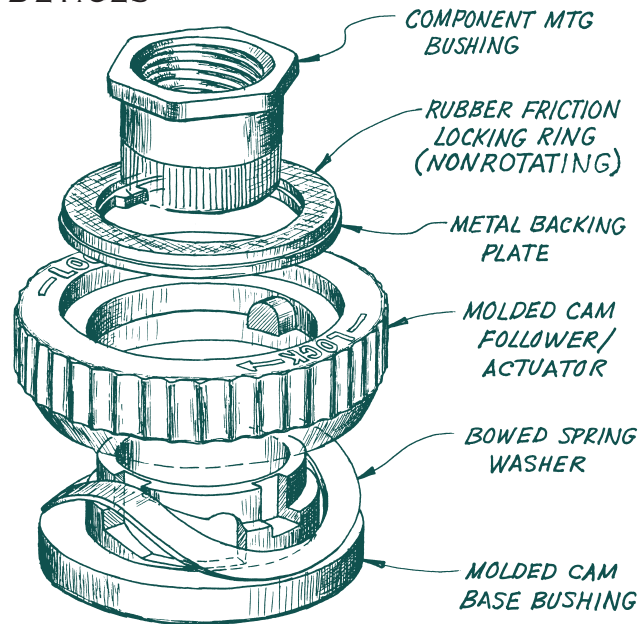

Knob Locks are positive friction locking devices for holding precise or critical control settings under conditions of shock and vibration. They are also useful where there is danger of accidental jarring or manual contact. Special splash-proof versions feature molded rubber inserts which prevent water leakage down into the control and also serve as dust seals.

- Positive friction locking system
- Resists shock, vibration, or accidental movement
- Tested under salt spray, humidity, and temperature conditions
- Occupies minimum panel space
- Used with standard off-the-shelf control knobs, .700, .900 and 1.250 diameter knobs
- No special mounting hardware or tools required
- Special water and dust-tight models available
- Made of highest quality materials
- Available in three sizes in either mirror or matte finish

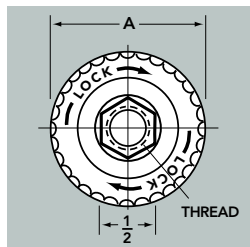
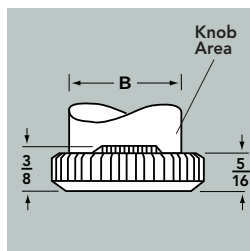

Part Number

	MS91528	Type	Finish	Overall Diam. A	Overall Diam. B	Thread
.700 Diam. Knob						
		Standard	Mirror	1"	.721	3/8-32
	1CC2B	Standard	Matte	1"	.721	3/8-32
		Standard	Mirror	1"	.721	1/4-32
	1CC2G	Standard	Matte	1"	.721	1/4-32
		Splash Proof	Mirror	1"	.721	3/8-32
	1DD2B	Splash Proof	Matte	1"	.721	3/8-32
.900 Diam. Knob						
		Standard	Mirror	1-5/16"	.928	3/8-32
	2CC2B	Standard	Matte	1-5/16"	.928	3/8-32
		Splash Proof	Mirror	1-5/16"	.928	3/8-32
	2DD2B	Splash Proof	Matte	1-5/16"	.928	3/8-32
1.250 Diam. Knob						
		Standard	Mirror	1-5/8"	1.269	3/8-32
	3CC2B	Standard	Matte	1-5/8"	1.269	3/8-32
		Splash Proof	Mirror	1-5/8"	1.269	3/8-32
	3DD2B	Splash Proof	Matte	1-5/8"	1.269	3/8-32

The above MS91528 designations are for reference only.

Series of knobs used in conjunction with knob lock are MS91528, EH71 and Contemporary.



STYLE KL701
.70 DIAM. KNOB



STYLE KL901
.90 DIAM. KNOB



STYLE KL1251
1.25 DIAM. KNOB

OPERATION & INSTALLATION

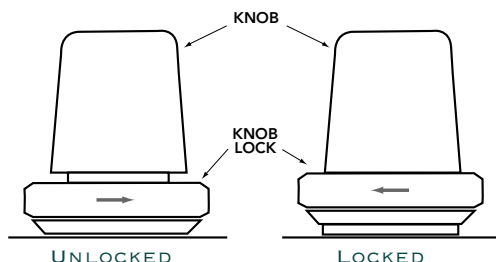

An eighth turn of the fluted skirt locks the control knob by forcing a rubber bushing against its lower surface. A critical control setting is not affected. An eighth turn to the left frees the knob to rotate freely. Used primarily with potentiometers and similar variable controls, knob locks mount directly to threaded control bushings replacing the nuts and lock washers usually supplied.

SHAFT LOCKS



SL100B & SL101R
1/4" MODEL



SL110B
KNOB LOCKING MODEL
1/4" MODEL



SL105B
1/8" MODEL

EHC Shaft Locks prevent control shafts from rotating under conditions of shock, vibration, or accidental contact. They form a dustproof and water-resistant seal at the shaft and also at the panel surface. One-piece construction, they are simple, effective, and inexpensive.

The Shaft Lock's tapered nylon collar grips the control shaft tightly forming a dust and water-tight seal and exerting an even frictional drag which resists accidental rotation. A molded lip at the outer edge of the base compresses against the panel surface to complete the sealing function of the device. To adjust the control smoothly and accurately, merely insert to screwdriver and turn — no unlocking and relocking required. Tests have demonstrated no significant change in locking torque and water sealing even after 10,000 full on — full off cycles.

Shaft Locks mount directly to the threaded bushings found on most potentiometers and other variable controls. Simply discard the nuts and washers supplied with the control, slip on the Shaft Lock, and tighten with any type of standard 1/2 inch wrench. Once in place, the Shaft Lock need never be loosened — a distinct advantage over conventional two-piece metal split bushing types.

Shaft Locks are available for 1/4 inch and 1/8 inch control shafts. Model SL-110B is designed specifically for use with .90 diameter standard EHC control knobs (see pages 2 through 5). SL-110B fits underneath the .90 diameter knob and is completely out of sight. It is often a replacement for more expensive and complicated locking devices and provides the same high quality performance as the regular models. When mounting SL-110B, it is sometimes advisable to mount the standard mounting nut behind the panel if the control's threaded bushing projects too far.

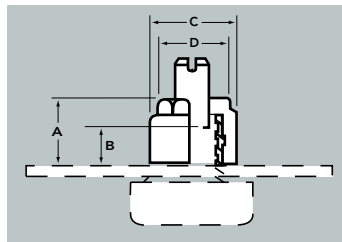

Part Number

	A Diam. max.	B Height max.	C Diam. max.	D Depth max.
SL-100B	.480	.348	.630	.505
SL-101R	.480	.348	.630	.505
SL-105B	.317	.223	.455	.380
SL-110B	.286	.187	.630	.505

"B" dimension is the maximum thread height above the mounting panel.

FEATURES

- Water and dust seal at shaft and panel
- Resists shock and vibration
- Tested for humidity, water immersion, and temperature shock.
- Passes 10,000 life cycling test
- Control adjustments may be without untightening nut
- One-piece construction
- Mounts with standard tools
- Highest quality materials

MATERIAL AND SPECIFICATION DATA

Nylon — MIL-M-20693

Insert — Brass per QQ-B-626 Nickel plated per QQ-N-290, Class 1, Type V

Shock — 50 g's

Vibration — 5 hours at 10 to 55 cps with amplitude of 0.06"

Water Immersion — 50 hours under 3 ft. head of water. Control shaft rotated every 10 hours.

Temperature Shock — Five cycles of 30 minutes at each extreme, -55°C and +85°C

Humidity — 150 hours at 95% relative humidity 40°C

Life Wear — 10,000 complete cycles

ORDERING GUIDE FOR SHAFT LOCKS

	Series	For Shaft Size	Control Bushing Thread Size	Series
Standard Models	SL-100B	1/4"	3/8 - 32 NEF-2	Black
	SL-101R	1/4"	3/8 - 32 NEF-2	Red
	SL-105B	1/8"	1/4 - 32 NEF-2	Black
Knob Locking Model*	SL-110B	1/4"	3/8 - 32 NEF	Black

*Use with any .90 diameter, or larger, ring or dial skirted round, skirted pointer, or crank knob.

SHAFT LOCKS

SHAFT LOCK ALL PLASTIC



AK-1047
5/16" HEX OD

Material: Nylon

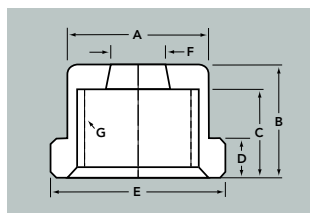

Part Number

	A Diam.	B Height	C Height	D Height	E Diam. max.	F Diam.	G Thread
AK1047-2-4	.288	.230	.180	.078	.355	.113	1/4-32
AK1049-2-4	.437	.257	.197	.120	.505	.113	1/4-32
AK1049-2-6	.437	.257	.197	.120	.505	.113	3/8-32
AK1049-4-6	.437	.257	.197	.120	.505	.240	3/8-32



CHASSIS AND CABINET BUMPERS



AK574

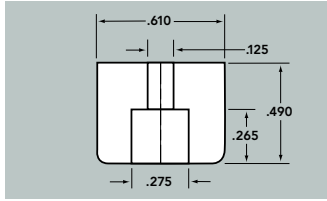

Low-friction polyethylene. Guards against scuffing. Supplied in either black or russet brown, with recessed hole for screw or bolt usage.

To order colors: 4- Black
7- Brown



AK575

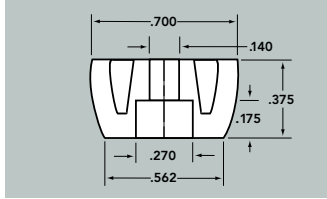

Low-friction polyethylene. Guards against scuffing. Supplied in either black or russet brown, with recessed hole for screw or bolt usage.

To order colors: 4- Black
7- Brown



AK576-4

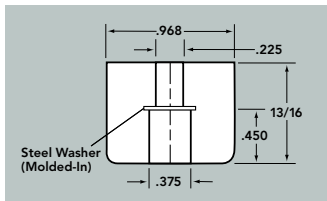

HEAVY DUTY.

Molded non-marring, high-tech strength neoprene with a molded-in steel washer for extra strength. Colors: Black standard, other colors available on special request.



AK577-8

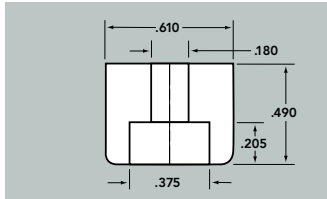

Low-friction polyethylene. Guards against scuffing. Supplied in white nylon; thru hole .180 diameter, C bore .375

RECESSED BUMPERS



REC2081S

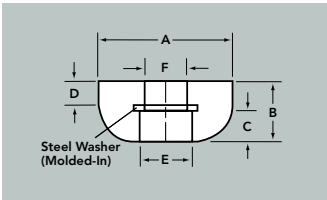

FIG. 1

Molded non-marring, high-tech strength neoprene with a molded-in steel washer for extra strength.



REC2082S

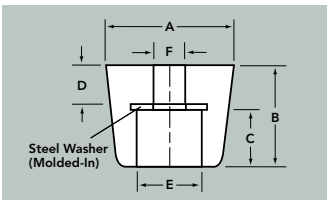

FIG. 2

Part Number	NUT CLEARANCE						Nominal Durometer
	A Max. Diam.	B Height	C Screw Head Depth	D Screw Shaft Depth	E Screw Base Opening	F Screw Shaft Width	
REC-2081S (fig.1)	5/8	5/16	3/16	1/8	1/4	3/16	75
REC-2082S (fig.2)	5/8	1/2	1/4	1/4	5/32	5/32	75
REC-2084S (fig.2)	3/4	3/8	3/16	3/16	7/16	3/16	75
04-00116-1 (fig.3)	.800	.870	.440	.215	.425	.190	-
04-00116-2 (fig.3)	.800	.870	.310	.215	.425	#10-24	-



717

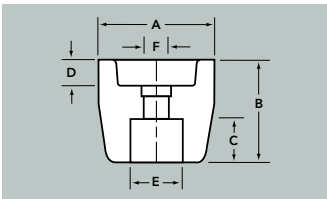

FIG. 3

Black Phenolic unthreaded (04-00116-1) and threaded (04-00116-2) bumpers.

JACK COVERS (TRIMMER COVERS)



Our jack covers fit jack or panel bushings and are used to keep out dust and moisture and to prevent inadvertent disturbance of control. Outer surfaces finished in standard colors of baked enamel.



PN J-1301

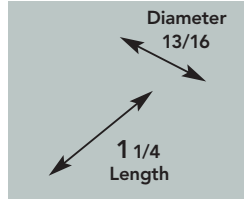

Part Number	A Dimension	Overall Height*	To COMPLETE PART NUMBER Color
PN J-1301-	.388	5/16	1, 2, 3, 4, 5, 6 or 7



PN J-1304

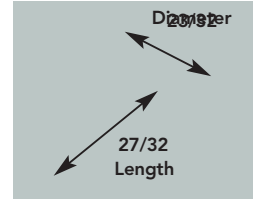

Part Number	A Dimension	Overall Height*	To COMPLETE PART NUMBER Color
PN J-1304-	.380	1/4	1, 2, 3, 4, 5, 6 or 7
PN J-13044-	.255	1/4	



PN J-1303

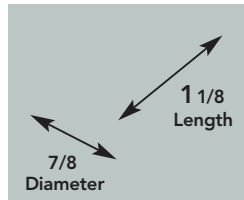

Part Number	A Dimension	Overall Height*	To COMPLETE PART NUMBER Color
PN J-1303-	.375	13/32	1, 2, 3, 4, 5, 6 or 7

Waterproof jack cover, gasket and nut



PN J-1305

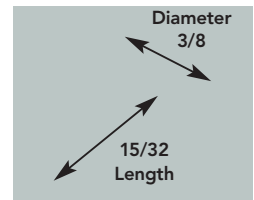

Part Number	A Dimension	Overall Height*	To COMPLETE PART NUMBER Color
PN J-1305-	.187	13/64	1, 2, 3, 4, 5, 6 or 7

Sub-miniatures

EXAMPLE: J-1301(1)

Jack Cover	Color
J1301	- 1

ORDERING GUIDE FOR JACK COVER FINISHES

Color	
1- Black Texture	5- Bright Nickel Plate
2- Smooth Gray	6- Red (top section only)
3- Smooth Olive	7- White (top section only)
4- Smooth Black	

"A" Dimension is diameter of opening in base of unit.

*Height of unit when closed.

Electronic Hardware Corporation's products have been used on military programs since the early 1950's and we are still **the major supplier** to the military. The acquisition of Raytheon Knob product line and the JAN Hardware Company makes Electronic Hardware Corporation the largest source of Military style knobs.

EHC is qualified to all major ground support, casted, and transilluminated knob specifications. Our quality system is in accordance with MIL-I-45208 and is certified to ISO 9001-2008.

Although this catalog shows many styles of military knobs, it represents only TEN PERCENT of the total that we have manufactured. Please contact the factory for your specific requirements.

EHC is an approved source for:

- MIL-K-25049C Report Number 323.11N-2/71
- MIL-K-3926A Report Number J101-6/68
- MIL-K-3926B Report Number J103-9/81
- MS91528 Report Number J101, 17-6/68 and J103-9/81

Our transilluminated knobs are designed to meet the requirements of:

- MIL-P-7788
- MIL-L-85762
- MIL-L-27160

The following list is only a partial representation of the military knob types and series we manufacture:

MIL Number	Catalog Page	MIL Number	Catalog Page
AN3220	8M	MS26519	9M
MS3926/1A	6M	MS90120	7M
MS3926/2A	6M	MS91522	14M
MS3926/3A	5M	MS91523	14M
MS21382	13T	MS91524	12M, 13M
MS21384	8T, 10T	MS91525	12M, 13M
MS21385	5T, 13T	MS91528	2M-5M
MS21386	16T	NAS120	10M
MS21387	13T	NAS121	10M
MS25165	12T	NAS123	10M
MS25166	12T	NAS124	10M
MS25167	13T	NAS125	10M
MS25168	14T	NAS539	8T
MS25169	11T	NAS1553	11M
MS25170	11T	NAS198	10M
MS26517	9M	PMS91528	6M
MS26518	9M		

MATERIALS

Resins—much of the growth of the injection molding industry is due to the continuing ability of resin suppliers to offer new and improved engineering materials. Today resins can meet specifications for mechanical, thermal, electrical and impact demands increasingly competitive in performance to metal at reduced processing costs.

EHC's participates in an ongoing evaluation process of new resins. Moldability, ease of processing and decoration are some of the analysis conducted. This process provides for a continuing effort to improve current production needs and prepare for future program demands.

- Good Mechanical Strength is of primary concern when choosing our materials. Where high mechanical strength is needed numerous reinforcements are used including glass fibers, mineral fillers, glass microspheres, all products that improve impact resistance.
- Electrical Resistance or Insulation make the use of EHC plastic products especially suited in electro-mechanical environments.

The plastic materials used in EHC parts have been carefully selected to meet the functional and aesthetic requirements of each product.

Thermoplastic – Materials with technical characteristics such as: ABS, nylon, TPR, polyamide, acetyl, polypropylene, polycarbonate, PPO and polyester resins. These materials are not always interchangeable.

MATERIAL SPECIFICATIONS

INSPECTION

Standard

Parts are considered commercially non-acceptable if an imperfection is visible when viewed at arm's length distance under normal lighting conditions. Parts will be viewed for a period not to exceed 3-5 seconds in daylight (or fluorescent light of approximately 70 foot candles) with the unaided eye at normal viewing distance of 24 inches, in the normal viewing plane.

Special

Jewelry-type inspection will be reflected in a higher unit-cost. Customer to provide EHC with written notice in advance of placement of order.

CHEMICAL RESISTANCE

Contact manufacturer for resistance factors prior to usage with chemicals.

Surface Finish

1. Gloss: Parts produced from a highly polished mold, or
2. Satin: Parts produced from a textured mold to remove glossiness,
- or
3. Textured: Parts produced from a pattern etched mold, or
4. Matte-finish: Parts produced from a secondary operation that provides a non-reflective plastic surface.

Appearance

Parts to be free of shrinkage in excess of .009" IN/IN on top surface and sides of molded knob, mold flow marks or "cold" spots, molding flash, chips or cracks, excessive gate marks and colors (for knob and skirt assemblies) to be consistent in shade and density for each order lot or release.

DECORATIVE INLAYS AND CAPS, FLAT ALUMINUM DIALS AND TAPERED ALUMINUM SKIRTS

Material: Aluminum

Surface Finish

1. Matte (frosted: Non-reflective surface appearance produced by mechanical brushing or chemical etching with clear anodized coating)
- or
2. Bright: Reflective surface appearance produced by mechanical or chemical means with clear anodized coating.

Inspection: See opening paragraph.

Appearance

Parts are to be free of scratches and blemishes. Colors to be consistent in shade and density for each order lot or release.

MARKINGS

Adhesion:

Markings cannot be removed from plastic surface by an adhesive material comparable to scotch tape.

Inspection: See opening paragraph.

Appearance:

All characters, lettering, border, and backgrounds must be complete and all lettering must be clear, visible, and legible. Colors to be consistent in shade and density for each order lot or release.

SET SCREWS

Hexagon Socket (also available: Spline Socket and Slotted)

1. Material: high grade alloy steel
2. Finish: Corrosion resistant/coating with clear, yellow or black finish
3. Hardness: Case hardened
4. Finish: Clear corrosion resistant coating
5. Point Style: Cup point

Location (nominal) of Screw(s) (if applicable)

1. One Screw
 - a) 180° from indicator
 - b) Adjacent to flat of shaft hole
2. Two screws: 90° and 180° from indicator

Thread

Class 3A

Screw Size, Length, Socket, Point, and Self Locking

Determined by manufacturer or per customer request.

INSERTS

1. Material: Aluminum or half-hard brass alloy.
2. Finish: Commercial nickel plate. Finish to be consistent and free of flaking.

Thread

Thread Fit: 2B gauge

SPRING CLIPS

Material: #1050C type spring steel

Hardness: Medium temper

Finish: Blue oil finish, or zinc phosphate

CHROME-PLATED PLASTIC (Thermoplastic only)

Processes

1. Electroplating, or
2. Vacuum metalizing

Surface Finish

1. Bright: High gloss reflective finish, or
2. Satin: Semi-gloss non-reflective finish

Adhesion:

Plating cannot be removed from plastic surface by an adhesive material comparable to scotch tape.

Appearance:

Parts to be plated over entire first surface area, consistent in shade and density for each order lot or release, free of first surface peeling, free of first surface flow marks and free of foreign matter under plated surface (e.g. dust)

PACKAGING

All products are packaged to insure that quality is not jeopardized during transit. Relative to the complexity of the part, product is:

- A. Individual bags, or
- B. Layer packaged on cardboard pads, or
- C. Bulk-packaged in cartons

PRODUCT DIMENSIONS: ± .015" unless otherwise specified.

PRODUCT CONCENTRICITY: .020" TIR

SHAFTHOLE DIAMETERS

- Round Shaft Hole: ± .002"
- Round Shaft Hole with Flat: ± .0035"
- Knurled Shaft Hole:
 - Solid Shaft: ± .002"
 - Split Shaft: ± .0035"

TORQUE SPECIFICATIONS

Torque is defined as the number of pounds required to strip molded-in inserts and stud heads from molded plastic part, flatten metal spring clip, strip serration of knurled plastic shaft hole or strip head of set screw.

Spring Diameter	Stripping Torque Inch Lbs.
.125	10
.187	17
6 mm	25
.250	25

Knurled Type Shaft Hole: All types 15 inch lbs.

Screw Size	Threads Per In.	Head Stripping Torque Inch Lbs.
#3	48	3-1/2
#4	40	4-3/4
#6	32	8-3/4
#8	32	18
#10	32	32

TENSION (push/pull specifications)

Tension is defined as the maximum number of pounds required to securely fit a press-fit knob onto the shaft and the minimum number of pounds required to remove the knob from the shaft.

Plastic Shaft Hole

Push: 15 lbs. Maximum Pull: 4 lbs. Minimum

Spring Clip Shaft Hole

Push: 20 lbs. Maximum Pull: 4 lbs. Minimum

Knurled Type Shaft Hole

Push 20 lbs. Maximum Pull: 4 lbs. Minimum

Shaft hole fit per customer specifications can be provided for an additional charge. Sample shaft and tension requirements must be forwarded to manufacturer.

THREADED INSERTS

(Standard Series and Selected Combinations – Unified Screw Threads)

Thread Fit: 2B Gauge

Thread Type	Thread Type
#6-32 UNC 2B	M4
#8-32 UNC 2B	M5
#10-32 UNF 2B	M6
1/4-20 UNC 2B	M8
5/16-18 UNC 2B	M10
3/8-16 UNC 2B	M12
1/2-13 UNC 2B	M16
5/8-11 UNC 2B	

THREADED STUDS

(Standard Series and Selected Combinations – Unified Screw Threads)

Thread Fit: Class 2A

Length: ± .020"

MOLDED THREADS

Thread Fit: Class 2A

SALES TERMS & AGREEMENTS

- TERMS:** Our terms of sale are 1/10 net 30 FOB Farmingdale, NY. Terms on tooling are 50% with order balance upon sample approval.
- RETURNS:** All returns must be approved by EHC and be assigned an EHC RMA number.
- QTY VARIANCE:** We reserve the right to over or under ship 10% on orders for non-standard parts.
- SHIPMENTS:** Usually UPS or FedEx prepaid and added, unless otherwise specified.
- DELIVERY:** Immediate and just-in-time delivery is available on most standard items.

SPECIFICATIONS FOR NON-STANDARD PRODUCTS MUST BE APPROVED BY EHC. SPECIFICATIONS WHICH CALL FOR CLOSER TOLERANCES, ENHANCED PHYSICAL PROPERTIES, OR MORE STRINGENT VISUAL REQUIREMENTS THAN THOSE PREVIOUSLY LISTED MUST HAVE SPECIFIC APPROVAL OF EHC'S SALES AND MANUFACTURING ORGANIZATIONS.

NOTE: SHRINKAGE, TOOLMAKERS VARIATIONS FROM CAVITY TO CAVITY, LIFE-CYCLE OF TOOLING, MATERIALS FROM MULTIPLE VENDORS, HUMIDITY, ETC. ALL HAVE AN EFFECT ON THE NORMAL DIMENSIONS OF PLASTIC PARTS. A PREMIUM CHARGE WILL BE ADDED TO THE UNIT-COST FOR THOSE CUSTOMERS REQUIRING EXACT TOLERANCES AND APPEARANCE. CONTACT MANUFACTURER FOR ADDITIONAL CHARGES.

STORAGE OF CUSTOMER OWNED ARTWORK PREPARATION, RAW MATERIALS AND SUPPLIES, AND TOOLING.

CUSTOMER SHALL NOTIFY EHC OF DISCONTINUANCE OF PRODUCT FOR WHICH CUSTOMER HAS PURCHASED ITEMS SO THAT ARRANGEMENTS CAN BE MADE TO RETURN OR DISCARD THEM. OUR STANDARD PRACTICE ASSUMES THAT ITEMS NOT USED BY THE CUSTOMER FOR A PERIOD OF TWO YEARS WILL BE CONSIDERED OF NO VALUE AND CUSTOMER WILL BE NOTIFIED OF OUR DECISION. FAILURE OF CUSTOMER TO RESPOND TO INQUIRY LEAVES DISBURSEMENT OF ITEMS AT THE DISCRETION OF EHC (AT NO CHARGE OR OBLIGATION).



INDEX BY STYLE NO.

STYLE	SIMILAR PART	PAGE	STYLE	SIMILAR PART	PAGE	STYLE	SIMILAR PART	PAGE
228	06-00446-0	18T	2013	FNA2013	14M	8503	MS21385 FIG3	5T
352	06-00313-0	18T	2066	FNA2066/3055	18T	8504	MS21385 FIG4	8T
432	06-00490-0	18T	2088	K2088	14M	8505	MS21385 FIG5	5T
456	533-030-54	13T	2201	MS91522	14M	8506	MS21385 FIG6	5T
458	RD THUMB	18T	2210	K2210	14M	8507	MS21385 FIG7	5T
459	RD239	13T	2270	BP258	10T	8508	MS21385 FIG8	5T
463	533-119-20	10T	2301	MS91523	14M	8509	MS21385 FIG9	13T
465	RC442	16T	2380	RD238	13T	8510	MS21385 FIG10	13T
470	533-119	10T	2409	MS91524 STYLE 9	12M	8601	MS21386 FIG1	16T
489	533-181	18T	2460	BP246	8T	8602	MS21386 FIG2	16T
494	CONCENTRIC	16T	2480	BP248	8T	8701	MS21387 FIG1	13T
507	BAR PULL SMALL	17T	2485	MSC485	12T	AK1047	PLASTIC SHAFT LOCK	21M
537	PENCIL	9T	2500	MS91525-0	13M	AK1049	PLASTIC SHAFT LOCK	21M
542	SMALL BAR	17T	2502	MS91525-2	13M	AK574	BUMPER	22M
543	BAR RD	17T	2504	MS91525-4	13M	AK575	BUMPER	22M
548	CONCENTRIC RD	17T	2505	MS91525-5	13M	AK576-4	BUMPER	22M
551	PENCIL	9T	2539	NAS539	8T	AK577-8	BUMPER	22M
557	BAR SQUARE	17T	2562	MS25165	12T	KL	KNOB LOCKS	20M
599	SCB-104717	26	2563	MS25166	12T	KRD15	REDUCTION DRIVE 10 TO 1	16M
688	19C32108-20	18T	2564	MS25167-P1	13T	KRD17	REDUCTION DRIVE 40 TO 1	16M
691	PENCIL	9T	2565	MS25168-P1	14T	KRD17	REDUCTION DRIVE 100 TO 1	16M
705	361C	18T	2566	MS25169	11T	-	MS26517	9M
800	K800	3M	2567	MS25170	11T	-	MS26518	9M
801	K801	3M	2580	BAR	17T	-	MS26519	9M
802	SMB-179515	26	2685	FNA2685	17T	PT	LOCKING	18M
803	SCB-16532	26	3081	FNA3081	18T	PTE	PUSH-TO-TURN	19M
804	SMD-415161	26	3180	HI ROUND	17T	RDL61	REDUCTION DRIVE 6 TO 1	16M
805	SMD-415223	26	3214	FNA3214	18T	REC2081S	BUMPER	22M
806	SMC-447226	26	3283	4042489	18T	REC2082S	BUMPER	22M
808	226707	13T	3300	0033	3M	S	MS915258 CLUTCH	17M
809	K809	3M	3670	FNA3670	8T	SL100B	SHAFT LOCK	21M
810	K810	3M	3674	FNA3676	10T	SL101R	SHAFT LOCK	21M
811	SMC-414680	3M	3676	FNA3676	10T	SL105B	SHAFT LOCK	21M
813	K813	3M	3680	FNA3680	18T	SL110B	SHAFT LOCK	21M
814	SMC-447052	26	3700	TT370	6T	-	MS26517-2	17T
814	SMC-91018	26	3710	TT371	6T	-	MS26518-1	17T
815	SMC-806328	3M	3720	TT372	6T	-	MS26519-2	17T
816	K816	3M	3730	TT373	6T	2120	NAS120	10M
817	K817	3M	3740	TT374	6T	2121	NAS121	10M
818	SMC-657408	14M	3750	TT375	6T	2123	NAS123	10M
820	SMB-144318	26	3760	TT376	6T	2124	NAS124	10M
894	SMC-414401	14M	3770	TT377	6T	2125	NAS125	10M
1020	K1020	14M	3480	8401	17T	2198	NAS198	10M
1021	K1021	14M	4420	RC442	16T	-	NAS1553-A	11M
1022	K1022	14M	4460	RC446	13T, 16T	-	NAS1553-B	11M
1047	FNA1047	18T	4480	RC448	16T	-	NAS1553-C	11M
1127	SMC-344849	3M	4740	PENCIL	9T	-	MS90120-1	7M
1328	K1328	3M	6060	PENCIL	9T	-	MS90120-2	7M
1338	K1338	8T	7510	PENCIL	9T	-	MS91528	2M
1376	K1376	14M	8201	MS21382 FIG2	13T	-	MS91528	3M
1389	K1389	14M	8401	MS21384 FIG1	8T	-	MS91528	4M
1390	K1390	14M	8402	MS21384 FIG2	8T	-	MS91528	5M
1502	K1502	12T	8403	MS21384 FIG3	12T	-	PMS91528-002-1	6M
1836	FNA1836	13T	8404	MS21384 FIG4	10T	-	PMS91528-002-2	6M
1925	K1925	9T	8405	MS21384 FIG5	10T	-	M3926/1-0	6M
1996	K1996	14M	8501	MS21385 FIG1	5T	-	M3926/3A	6M
2012	K2012	14M	8502	MS21385 FIG2	5T	-	M3926/1-3	6M



Adjustable Clamping Handle

EHC's adjustable clamping handles are operated by a simple "lift and rotate" movement. Each handle includes a ratchet for use in tight spaces. Perfect wherever there is a clearance issue, if the space is too tight for a regular knob, or whenever extra torque is required.



PLASTIC CLAMPING HANDLES

PLASTIC CLAMPING HANDLES

Reinforced nylon handles with cap and female steel insert or zinc plated steel threaded stud. Just depress the cap to easily park in the desired position. Ideal for use in tight spaces. ENGLISH and METRIC sizes standard. Black standard. Available in 4 sizes.

**press cap
to reset**

Just push the cap and park in the desired position for an easy adjustment.

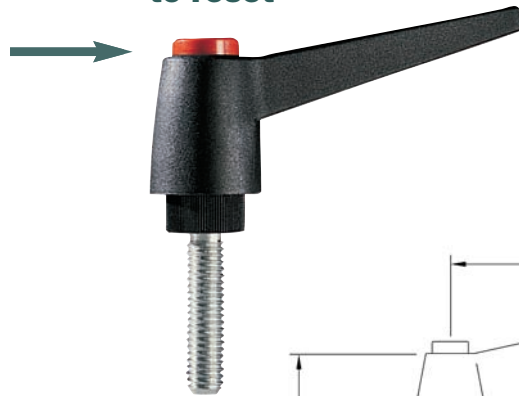

Orange handle with a selection of 8 different cap colors on request.

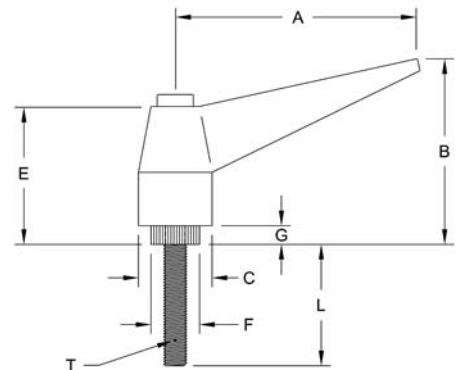

Your choice of a steel insert or a brass insert.

Available in 4 standard sizes.



Our handles are very easy to use.
Find the Clamping Handle you need at
www.ehcknobs.com

Also Look for Our Metal Clamping Handles.

