

Pollak[®]

by  SMP[®]



ELECTRICAL CONTROLS APPLICATION GUIDE

For Trucks, Bus, Off-Road,
Recreational Vehicles, Marine,
Agricultural, Emergency
Vehicles and Automobiles

Pollak®

by  SMP®

Since 1909, Pollak® has provided the transportation industry with innovative designs, reliable manufacturing, high quality standards, competitive pricing and low life cycle costs. More than 1,000 employees located in three manufacturing locations totaling approximately 250,000 square feet of design, test and production space are now providing custom and standard components to OEM's and aftermarket suppliers in automotive, light, medium and heavy duty truck, agricultural, construction equipment, marine and related industries. Pollak® excels in its ability to design and manufacture from the concept stage through manual, semi-automatic and fully automated, high volume production. Pollak® is a certified ISO9001/ QS9000 manufacturer and has also earned Q1 preferred status at Ford, General Motors' Mark of Excellence, Chrysler's Gold Pentastar, Navistar V and similar rankings with PACCAR, Freightliner, John Deere, Case, Caterpillar, Borg-Warner and other respected OEM's.



For senior design engineers at major OEM's, the operator of a heavy duty truck or the weekend camper, the name Pollak® has always symbolized technology and quality.

ELECTRICAL CONTROLS



CONNECTORS/
ADAPTERS

SWITCHES

CIRCUIT
BREAKERS

SPECIALIZED
ELECTRICAL
PRODUCTS

FUEL TANK
SELECTOR
VALVES

BACK-UP
ALARMS

Pollak®

by  SMP®

PollakAftermarket.com

ALPHABETICAL INDEX

(See Numerical Index, pages 66-67)

Adapters	14,16-17	Ignition Starter & Lock Switches	29-34
Adaptor Housing, Connector	9	Ignition Starter & Lock Switches (Marine)	33
Alarms, Back-up	55-58	Inserts, Plugs	6
Anti-Restart Ignition Switches	29-33	Inserts, Sockets	7-8
Axle Switches	24,39	Master Disconnect Switches	35,36
Back-up Alarms and Switches	55-58	Molded Connectors	13
Back-up Lamp Switches (Ball Operated)	27-28	Momentary Start Switches	25,26
Battery Disconnect Switches	35-36	Momentary Start Switches (Marine)	26
Battery Jumper Terminals	12, 49	Panel Indicator Light (Pilot Light)	49
Boot Nut, Starter Switch	26	Plug Interiors, Connector	6
Brackets, Connector	8,10,12,14,15	Plunger Switches	26,39
Buzzer	49	Push/Pull Switches (Marine)	24
Circuit Breakers	40-46	Push/Pull Switches	24
Circuit Breakers Brackets	45	Rocker Switches	21,22
Circuit Breakers Sockets	9	Rocker Switches Accessories	22
Circuit Breakers Junction Box	48	RV Connectors	10-15
Connector Hardware Kits	7,10	Sealed Beam Connectors	49
Connectors, Molded	13	Starter Solenoid Switches	38
Connectors, Trailer	5-13	Stop Light Switches	39
Dimmer Switches	38	Terminal Blocks	48
Displays (Merchandising)	59-64	Toggle Accessories	21,22
Door Switches	39	Toggle Switches	19-22
Electronic Dimmer Switches	37	Trailer Connectors	6-15
Fuel Tank Selector Valves	51-54	Transmission Mounted Switches	27,28
Fuse Blocks	48	Universal Connector Brackets	8,10,14,15
Fuse Holders	48	Valves, Electrical Fuel Tank Selector	52-54
Fuse Panels	48	Value Line Connectors and Adapters Wiring	64
Harness, Trailer Wiring	14,16	Color Codes	65
Horn Buttons	49		

WARRANTY

Our products are warranted to be free of manufacturing defects for one (1) year after date of manufacture. Buyer's exclusive remedy and seller's sole liability hereunder shall be limited to refund of the purchase price or replacement of product shown to be other than as warranted. Conditions resulting from misuse, negligence, accident or improper installation, maintenance or application shall absolve seller of all liability. The foregoing constitutes the sole warranty of Pollak® with respect to its products and is in lieu of all other warranties, expressed or implied, including any implied warranty of merchantability or fitness for a particular purpose. In no event shall Pollak® be liable of consequential or special damages.

The product information published in this catalog is subject to change without notice. Changes to materials, finishes, technical specifications and other product characteristics may be necessary at our discretion. It is the buyer's responsibility to determine the suitability of the Pollak® device for its application. Pollak® makes no warranties, and assumes no liability as to the suitability or sufficiency for buyer's application of the device.

CONNECTORS & ADAPTERS

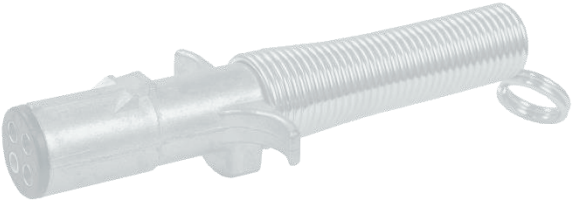
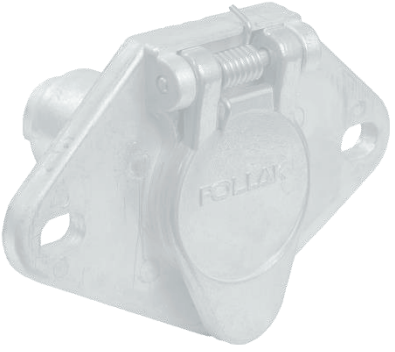

7-POLE PLUGS

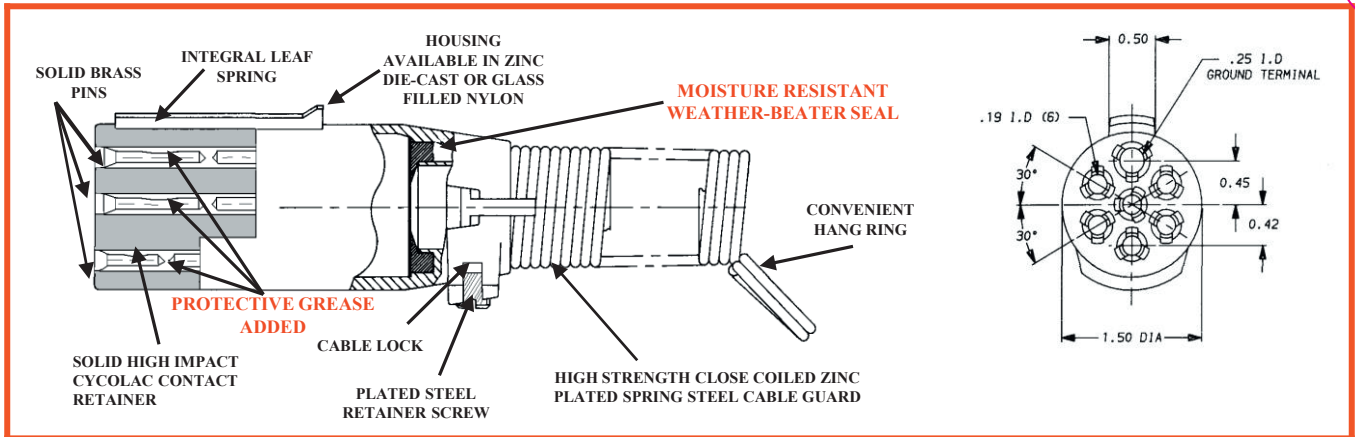

ZINC DIE-CAST

GLASS FILLED NYLON

Insertion and Pull-Out Requirements

- Meets and exceeds all standards of **SAE J560**.
- Floating pins for ease of alignment and maximum contact.
- Will accept the widest range of wire gauges, from #16 wires to #8 ground wire.
- Tapered design fits comfortably and conveniently for easy hand-position pull. Jumbo finger pull grips and two hang-up holes.
- High-impact cycloc interior with extended lip for easy removal and replacement.
- Solid brass terminal screws.
- 40 amps continuous duty @ 6-28 VDC.
- WeatherBeater seal accommodates .450 minimum wire diameter.

11-902
Weather-Beater Plug with Cable Guard



11-702
Standard 7-Pole Plug with Cable Guard

11-710
Standard 7-Pole Plug with Cable Guard



11-910
Weather-Beater Plug with Cable Guard

11-900
Weather-Beater Plug

11-700
Standard 7-Pole Plug



11-704
Standard 7-Pole Plug



11-904
Weather-Beater Plug

NOTE: Pollak's[®] Terminal Pins are machined from solid brass bar stock unlike some competitors that provide unplated terminal pins stamped from sheet metal. Brass terminals ensure minimum voltage drop and dielectric grease protects against corrosion and resistance.

NOTE: Pollak's[®] 7-Pole connectors are manufactured from quality materials and will help reduce maintenance cost and down-time associated with electrical failures.

ACCESSORIES

11-762
Rubber Boot
Seals against dust and moisture, 2.5" long. For .460-.720 dia. cable, fits 11-852, 11-700, 11-900, 11-704, 11-904.



11-763
Cable Guard
Plated steel, 3.56" long, fits 11-700, 11-704, 11-900, 11-904, and 11-852



11-764
Plug interior for 11-700, 11-702, 11-704, 11-710, 11-900, 11-902, 11-904, 11-910.
Supplied with mounting screw.



7-POLE SOCKETS

- Meets and exceeds all standards of **SAEJ560** (SAE applies only to solid pins)
- Floating pins for ease of alignment and maximum contact.
- Optimum slant mount and drain slot rid housing interior of accumulated moisture.
- Will accept the widest range of gauges from #16 wires to #8 ground wire. Ground Terminal Pin #1 will accept #14 gauge min. to #8 gauge max. Other terminals will accept #16 gauge min. to #10 gauge max.
- 40 Amps continuous duty @ 6-28 VDC.
- Self grounded. (Zinc Die-Cast Units Only) to #1 Ground Terminal.
- Stainless steel spring.
- Recommended Mounting Hole is 2" diameter
- Interchangeable with competitive makes.

No.	Color	Wire Gauge	FMVSS-121 Anti-Lock Gauge	Circuit
1	White	10	8	Ground Return
2	Black	12	12	Clearance, Side Marker and Identification Lamps
3	Yellow	12	12	Left Turn & Hazard Signal
4	Red	12	10	Stop Lamps & Anti-Lock Devices
5	Green	12	12	Right Turn Signal & Hazard Signal
6	Brown	12	12	Tail, Rear Clearance Marker, License Plate Lamp
7	Blue	12	12	Auxiliary Circuit / ABS Power

WIRE INSERTION STYLE SOCKETS

DRAIN SLOT IN COVER

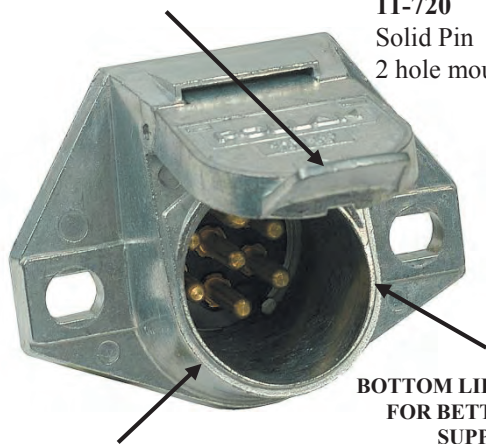

BUILT-IN OPTIMUM SLANT FOR DRAINAGE

BOTTOM LIP EXTENDED FOR BETTER PLUG SUPPORT

ZINC DIE-CAST

11-720
Solid Pin
2 hole mount

11-721
Split Pin
2 hole mount



11-729
Solid Pin
3 hole mount

11-730
Split Pin
3 hole mount

POLLA/GLASS GLASS FILLED NYLON

11-724
Nylon socket
Split Pin



11-723
Nylon socket
Solid Pin

ACCESSORIES

11-761
7 Pole Socket Rubber Socket Boot for 11-720, 11-721, 11-723, 11-724, 11-729, 11-730 and 11-851; seals against dust and moisture, 1.5" long. For .460-.720 diameter cable.



11-780
Neoprene rubber gasket for 3 hole mount die-cast sockets. May be used as template



11-773
Same as 11-780 except for 2 hole mount sockets.

11-771
7-Pole Socket bracket. Fits all 7-Pole Sockets including 11-851.



11-781
Hardware Kit for 7-Pole Zinc Die-Cast Socket



11-777
Hardware Kit for 7-Pole Plugs (except RV)

11-779
Hardware Kit for 7-Pole Molded Pollak/Glass Sockets

7-POLE SOCKETS

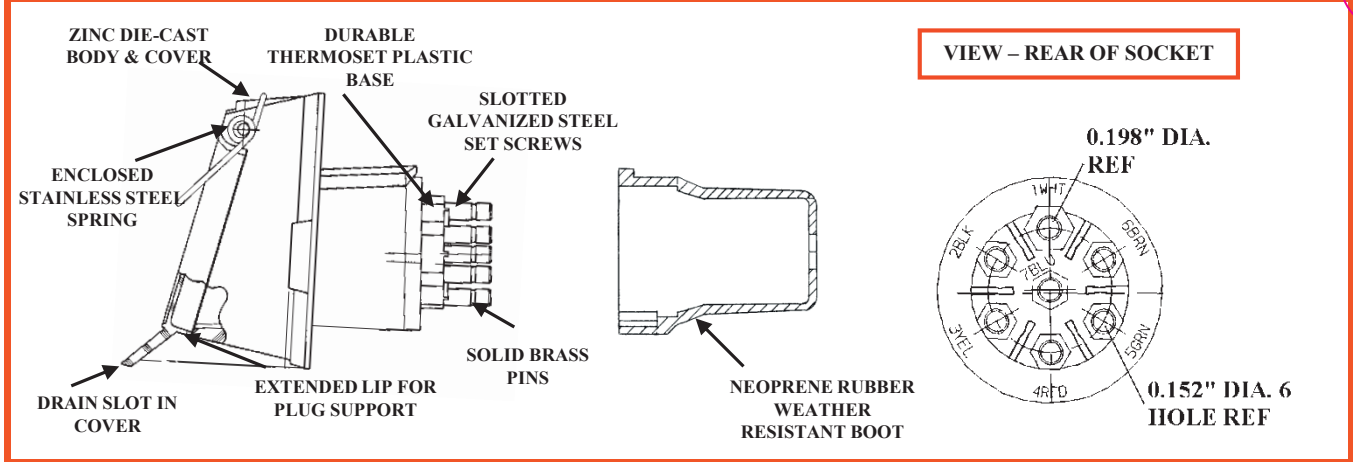

RING TERMINATION STYLE SOCKETS

11-785

Same as 11-720 except with rear threaded terminals for ring terminals. Solid Pins.

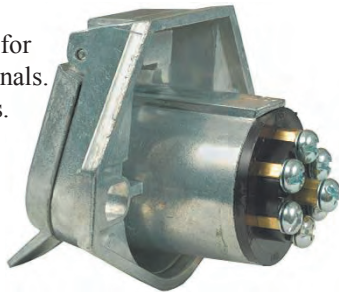

Note: For some applications ring terminals provide a better mechanical connection than set screws when properly installed.

BULLET TERMINATION STYLE SOCKETS

11-786

Bullet-Style solid brass terminals for push-on terminals. Will accept straight or "right angle" terminals. Extended hinge pin and external spring for increased closure force.

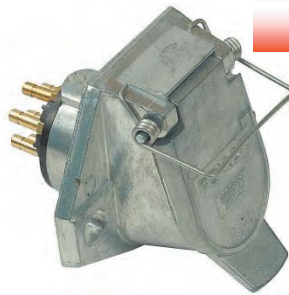

11-797

Same as 11-786 except without extended hinge pin and external spring. Solid Pins

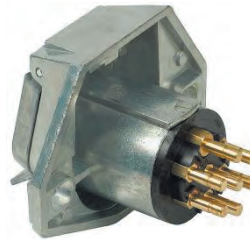

11-833 (Not Shown)

Same as 11-797 except with glass filled nylon shell and lid

ISO TYPE CONNECTORS

12-812

ISO 7-Way Connector Socket



12-811

ISO 7-Way Plug with cable guard



7-POLE SOCKETS WITH REPLACEABLE CIRCUIT BREAKERS

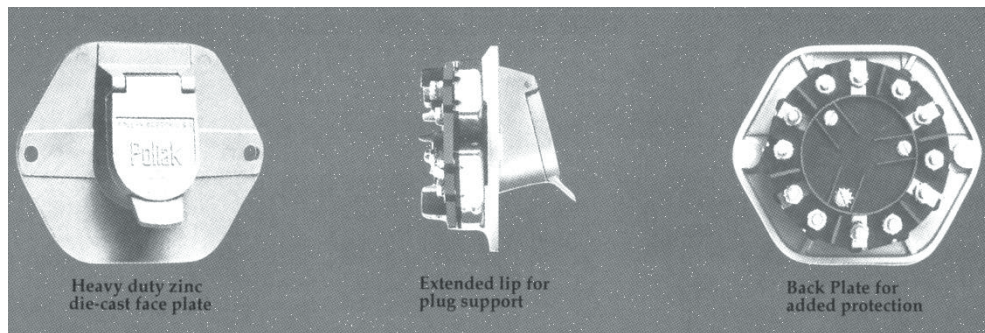

Heavy duty zinc die-cast face plate

Extended lip for plug support

Back Plate for added protection

Base plate and back plate made from rugged glass filled nylon to resist breaking. Bottom lip has been extended to allow for better plug and cable support. Drain hole has been incorporated into the housing to allow accumulated moisture to escape. Will accept the widest range of wire gauges from #14 wire to #8 ground wire. Will accept all plugs conforming to **SAE J560** specifications. Ground may be tied to any screw mounting the rear terminal plate. Designed to provide easy serviceability of circuit breakers. Recommended that positive feed be attached to auxiliary post on circuit breaker.

WIRE INSERTION STYLE

11-732
Solid Pin



11-733
Split Pin

Standard socket adapted to circuit breaker mounting plate without breakers. For use as a replacement of original equipment when circuit breaker protection is not required.

RING TERMINATION STYLE

(Not shown) **11-796**
Split Pin

Metal Circuit Breaker



Plastic Circuit Breaker



Glass filled nylon nose box offers more durability and weight saving features. Replaces old style heavy weight metal boxes which can cause short circuits.

Amperage	Pin Type	Part No.	Replacement Circuit Breaker Metal Housing	Replacement Circuit Breaker Plastic Housing
15	Split	11-735	54-115	*
20	Solid	11-736	54-120	54-120PL
20	Split	11-737	54-120	54-120PL
30	Split	11-739	54-130	54-130PL

COMPONENT PARTS

Part No.	Description
11-801	Adapter Housing Gasket
11-802	Adapter Housing (Includes Grommet and Screws)

11-801
Adapter Housing Mounting Gasket provides weather resistant protection against rain and snow.



11-802
Adapter Housing



6-POLE CONNECTORS

6-POLE SOCKET

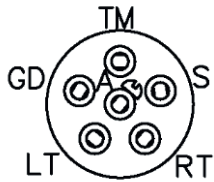

(Auxiliary in center)

Number	Color	Circuits
GD	White	Ground Return
TM	Brown	Tail Lights
LT	Yellow	Left Turn
S	Red	Stop and/or Electric Brake
RT	Green	Right Turn
A	Blue	Auxiliary Circuit (Center)

6-POLE PLUG

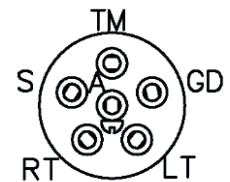

(Auxiliary in center)

Complete Assemblies (Plug and Socket)

Part No	Plug	Socket
11-600	11-604	11-607
11-602	11-604	11-608
11-603	11-604	11-609

11-603 Assembly incorporates concealed terminals on socket side for exterior mounting. Recommended for RV and flat bed trailer use.

Three socket versions to choose from: Exposed terminals, Rubber boot coverage, or Die-Cast shell coverage. High impact plug interiors keyed for proper assembly. Machined brass terminal pins for best conductivity, terminals accept up to #12 gauge wires. Plug available with or without cable guard. Replaceable plug interior helps reduce maintenance costs. Plated steel cable guard prevents cable chafing. Two 1/4" diameter mounting holes on 6-Pole sockets. 2-7/8" diameter on center. Mounts through 1-3/8" diameter hole.

Note: Pollak's® 4-pole and 6-pole interiors are secured with a key and keyway to eliminate twisting (disorientation) and breakage with make and break forces that apply in normal function



11-604
Plug, no
cableguard

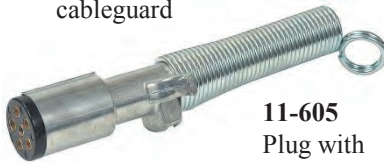

11-605
Plug with
cableguard



11-607
Socket, exposed
terminals



11-608
Socket with
rubber boot



11-614
Black Plastic
Socket with
metal lid



11-609
Socket,
Concealed
Terminals

11-720
6-Pole all Plastic
Socket with
rubber boot



11-613
Connector Plug
Chrome Plated

ACCESSORIES

11-627
Connector Bracket Designed to fit under the trailer tongue, ball, or 2-hole frame mounting. Heavy gauge with black zinc coating for protection against rust and corrosion. Fits connectors 11-400, 11-408, 11-500, 11-600, 11-603, and 11-614.



11-617
Same as 11-627 except without black zinc coating for protection against rust and corrosion

11-647
Connector Bracket for 4-way or 6-Way Sockets. Heavy gauge with black zinc protective coating.



11-606
Plug interior



11-616
Rubber Boot for 11-607
and 11-614 Sockets

4 & 5-POLE CONNECTORS

4-POLE SOCKET

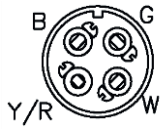

4-POLE PLUG

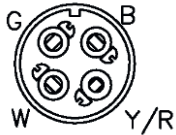

4-POLE POS	5-POLE POS	Color	Circuits
W	1	White	Ground Return
G	5	Green	Right Turn & Brake Lights
Y/R	3	Yellow or	Left Turn & Brake Lights
	4	Red	
B	2	Brown	Tail Lights

5-POLE SOCKET

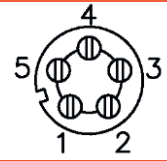

5-POLE PLUG

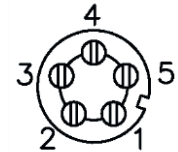

4-POLE CONNECTORS - 12-24 Volts, 35 Amp.

- Zinc Die-Cast 4-pole unit incorporates many new and improved features.
- Extended exterior and socket conceals terminals.
- Unique cable clamp prevents chafing, gives more cable support, and saves installation time.
- Integral finger grips for positive pull, difficult to shake loose.
- Stainless steel spring.
- Dust and water resistant.
- Polarized for proper wiring
- Terminals accept up to #12 gauge wire.
- Two 1/4" diameter mounting holes on 4-pole sockets. 2-7/8" on center. Mounts through 1-3/8" diameter hole.

Interchangeable with competitive brands.

11-402
Plug, no cable guard



11-404
Connector socket

11-403
Plug with cable guard



11-400
Consist of 11-402 Plug and 11-404 Socket.



4-POLE CONNECTORS - Chrome Plated, 12-24 Volts, 20 Amp

- Polarized design.
- Chrome Plated Die-Cast Zinc with high impact insulators and split brass contacts.

11-409
Connector Plug



11-410
Connector socket



11-408
Consists of 11-409 Plug and 11-410 Socket

5-POLE CONNECTORS - 12-24 Volts, 15 Amps

- Polarized design.
- Chrome plated zinc housing with spring loaded cover.
- Durable interiors.
- Split brass contact for maximum current carrying capacity.
- Mounting holes 1 3/4" diameter on centers.

11-502
Connector socket



11-500
Consist of 11-501 Plug and 11-502 Socket

11-501
Connector plug



SINGLE POLE CONNNECTORS

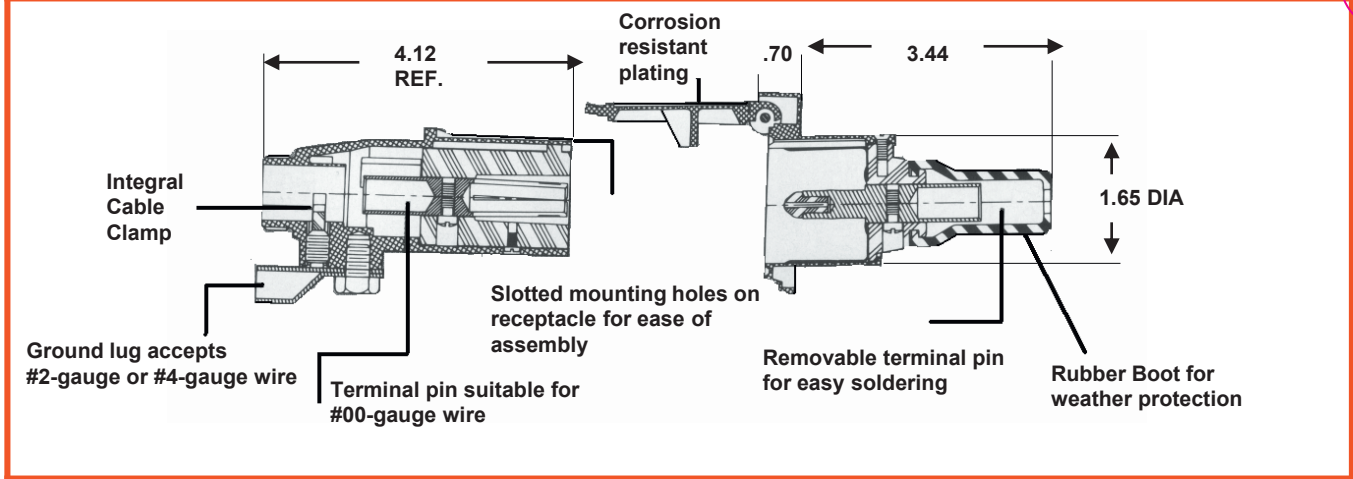

This rugged Single-pole Connector has a continuous duty capacity of 300 amps, and is ideal for many power applications on trucks, agricultural equipment, utility vehicles, winches, light air-craft ground equipment, etc. The connector is interchangeable with competitive brands.

Provides power for auxiliary equipment from battery.

11-850
Consist of 11-852 Plug and 11-851 Socket

11-852
Plug



11-851
Socket



11-853
Consist of 11-852 Plug and 11-763 Cable Guard



TWO POLE CONNECTORS

12-801
2 Pole Socket, 200 Amp service. One pole positive, one pole negative. Terminals accept 4 gauge cable.



12-800
2 Pole Plug with cable guard. 200 Amp Service. One pole positive, one pole negative. Terminals accept 4 gauge cable.

CONNECTOR ASSEMBLIES

12-24 Volts 20 Amp. Polarized design with high impact interior and split brass contacts for a perfect fit to ensure maximum current carrying capacity. Outer sleeves are unaffected by ozone or weather.



11-405
4-Pole Complete Assembly
12-24 Volts, 20 Amp
Car End Trailer End



11-200
2-Pole Complete Assembly
12-24 Volts, 20 Amp
Trailer End Car End

AUTOMOTIVE, MARINE, RECREATIONAL VEHICLES, TRUCKS

12 Volts, 15 Amps. Molded Inline connectors (Flat Type) are an economical means of connecting electrical systems. Wires are color coded for easy installation. Standard 18 gauge automotive wire, 12 " wire length, except where noted. Polarized design to insure proper connection. Molded case offers all-round weather protection.

FLAT TYPE



12-200
2-Pole Complete Assembly,
18 gauge wire.



12-403
4-Pole Complete Assembly,
18 gauge wire.



12-404
4-Pole Complete Assembly with
48" wire leads of female (car) side.
12" leads on male (trailer) side

SQUARE TYPE



12-600
6-Pole Complete
Assembly 18 gauge wire.



12-601
6-Pole Complete Assembly
with 48" wire leads on female (car)
side. 12" leads on male (trailer) side.



12-300
3 Way Male to Female
12" Loop



12-400: 4 Way Boot Cap



12-500: 5 Way Flat Female 60"



12-421: 4 Way Flat 12" Loop
12-412: 4 Way Flat 24" Loop
12-422: 4 Way Flat 36" Loop
12-423: 4 Way Flat 48" Loop
12-413: 4 Way Flat 60" Loop
12-414: same as 12-413 with boot covers
(all parts above are 4 Way Male to Female)



12-401: 4 Way Flat Female 12"
12-425: 4 Way Flat Female 48"

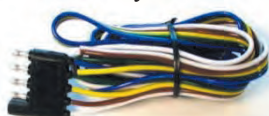

12-501: 5 Way Flat Male 60"

12-418: 4 Way Flat Male 12"
12-424: 4 Way Flat Male 48"

12-419: 4 Way Flat Male 12" Wishbone
12-405: 4 Way Flat Male 24" Wishbone
12-415: 4 Way Flat Male 36" Wishbone
12-417: 4 Way Flat Male 48" Wishbone
12-402: 4 Way Flat Female 48" Wishbone

7-Pole RV Style Socket



11-893 - RV Socket 12V, 30 Amps



12-711U
Mounting
Bracket



11-998
Interlocking mating
connector to the 11-893
Socket and 4' Harness.

- Pollak's® sealed RV socket is designed to be dependable in one of the harshest mounting environments for an electrical device - an exposed external mounting under the rear bumper of a sport utility or pickup truck. This connector design continues to earn the distinction of becoming the industry standard.
- Manufactured from high-impact nylon that solves corrosion problems and eliminates rusting when mated with special interlocking sealed connector.
- Socket lid features stainless spring and runner gasket to guarantee against moisture intrusion when closed. Socket lid also designed with slot to prevent sand and dirt from impairing closure and lid has wiring diagram on cover to facilitate installation.
- Socket lid also has a drain slot and is angled down for drainage.
- Terminal pins are tin plated copper alloy providing higher conductivity and less resistance and are sealed at the back of socket with silicone sealant to prevent moisture from making contact with mating connector.
- Fits Ford style and new universal Pollak® 12-711U mounting bracket for other OEM applications – Includes mounting hardware.

SOCKET KITS

&

7-Pole RV Style Socket

11-898P

Includes 11-893 Socket, 12-711U Bracket, Interlocking Connector and 4' Harness assembly with 0.5" convoluted tubing, and 7-wire leads color coded to RVI Standard (**SHOWN**)

11-990P

Includes 11-893 Socket and 12-711U Bracket
NEW – Includes mounting hardware.



11-916

New 'twist and lock' socket, suitable as a replacement for Pollak OEM sockets.



ADAPTERS

11-933

Rectangular-To-Round Harness Adapter.

- Fits OEM Harnesses.
- Mates with Pollak® Socket 11-893 and 11-932P



11-933
Adapter

11-893 Socket



11-938 Kit

11-893 Socket & 11-932 T-Connector

11-932

T-Connector

- Adaptor for 5th Wheel & Bumper Mount Socket
- Quickly & Easily Installs a Second RV Socket
- Plug and Play without Splicing into OEM Harness
- Fits GM and Ford Trucks and SUV's
- Fits Chrysler Trucks when used with 11-933 Adapter
- Mates with Pollak® Socket 11-893



7-POLE CONNECTOR

12-705 Series (7-Pole Set) Black Pollak® Plastic

12-705E	Complete Set (12-707E and 12-706E)
12-706	Trailer-End Only Plug
12-707E	Car-End Only Socket
12-709	12-705E Plug & Socket with 12-711U Bracket
12-712EV	12-707E with a 12-711U Bracket

Plastic connector set eliminates rusting, poor appearance and difficulty in plug removal. Design offers dual grips for ease of plug removal from socket and incorporates vinyl inserts to keep out dirt and moisture. Interior design prevents internal short-circuiting, and the safety latch prevents damage from accidental pull-away. Color coded to RV1 standards

12-706 Trailer End



12-707E Car End

12-702 Trailer End



12-703 Car End

12-700 Series (7-Pole Set) Metal

12-700	12-703 Socket & 12-702 Plug
12-702	Trailer-End Only Plug
12-703	Car-End Only Socket
12-704	12-700 Plug & Socket with 12-701U Bracket
12-710	12-703 with a 12-701U Bracket

Traditional metal connectors. Heavily plated for maximum weather and corrosion resistance. Stainless steel cover spring. Jumbo welded pistol grip. Unique safety latch prevents damage from accidental pull-away. Specially designed vinyl inserts keep out dirt and moisture. Color coded to RV1 standards.

RECOMMENDED WIRE GAUGE			
No.	Color	Gauge	Description
1	White	10	Ground Return
2	Blue	12	Electric Brake
3	Green	14	Tail, License and Running Lights
4	Black	10	Battery Charge
5	Red	14	Stop & Left Hand Turn Signal
6	Brown	14	Stop & Right Hand Turn Signal
7	Yellow	14	Auxiliary Circuit

UNIQUE INTERIOR DESIGN ELIMINATES SHORTING OUT-

Non-corroding, shock-resistant interiors with unique terminal reinforcer dams that eliminate short circuiting by preventing contact from spreading.

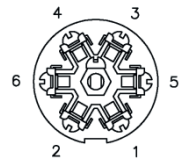

Center pin will take up to 8-gauge wire for battery charge system.

9-POLE CONNECTOR

- Staking methods proven in long term usage. No possibility of molding compound contaminating contacts to cause "dead spots".
- Unique method of machining from solid bar (not stamping) and spring loading contacts give long trouble-free service. Over 1.5 million trucks utilize this type of heavy duty connector contacts.
- "Floating Pins" originating with POLLAK® and a standard for the trucking industry are self-aligning offering continuous wiping action and the most positive contact.
- Terminals designed for 2-8 gauge, 2-12 gauge and 5-14 gauge to new industry standard for minimum voltage drop.
- Contacts on BOTH trailer and car side spring loaded. Completely FIELD serviceable.



12-907 Car End



12-906 Trailer End

12-905 Series (9-Pole Set)

12-905	Complete for towing vehicle and trailer side
12-906	Trailer Side
12-907	Towing vehicle side
12-701U	Bracket for towing vehicle

RECOMMENDED WIRE GAUGE			
No.	Color	Gauge	Description
1	White	8	Ground Return
2	Blue	12	Electric Brake
3	Green	14	Tail, License and Running Lights
4	Black	8	Battery Charge
5	Red	14	Stop & Left Hand Turn Signal
6	Brown	14	Stop & Right Hand Turn Signal
7	Yellow	14	Back-Up, Auxiliary Ground or Circuit
8	Gray	12	Auxiliary Circuit
9	Orange	14	Reefer (Tag) or Stop

MOUNTING BRACKETS

Right Angle Mounting Brackets for: 11-893, 12-703, 12-707, 12-907 **NEW** - Includes #11-926 mounting hdwre.



12-711U
Black Epoxy Coated for protection against rust and corrosion

12-701U
Constructed of Heavy Gauge Steel. Same as 12-711U but without black epoxy finish.

Trailer Tow Accessories

TRAILER WIRING TIPS

Avoid splices wherever possible * Establish a solid electrical ground * Maintain clean and weatherproof wire connections
* Make sure that the various wires and harnesses are free of stress and are not dragging or likely to be snagged *

12-717 Connector Adaptor (6-Pole to 4-Pole)

- Converts 6-Pole Round Connector to a 4-Pole molded connector.
- Quick and easy to connect.
- Non-corrosive nylon shell and insert.
- Eliminates makeshift jumpers.



12-716 Connector Adaptor (7-Pole to 4-Pole)

- Converts 7-Pole Blade Connector to a 4-Pole molded connector.
- Allows one vehicle to tow either campers or boat trailers without electrical brakes.
- Connects ground, L.T., R.T., and Stop Circuits.
- Tethered cap for protection from sand, dirt or moisture intrusion.
- Non-corrosive nylon shell and insert.
- Eliminates makeshift jumpers.



12-744 Connector Adaptor (7-Pole to 5-Pole; not shown)

12-718 Connector Flex Adaptor (7-Pole to 5-Pole)

- Converts 7-Pole Blade Connector to a 5-Pole molded connector.
- Allows one vehicle to tow either campers or boat trailers with electrical brakes.
- Quick and easy to connect.
- Full-length plug shell insures positive latching.
- Non-corrosive nylon shell and insert.



12-743 Connector Flex Adaptor (7-Pole to 4-Pole; not shown)

12-719 & 12-729 Connector Adaptor (7-Pole to 6-Pole)

- Converts 7-Pole Blade Connector to a 6-Pole Round Connector Plug.
- Allows one vehicle to tow either campers or Utility trailers.
- Quick and easy to connect.
- Non-corrosive nylon shell and insert.
- 12-719 Adapter had brake pin in center of 6-Pole (Shown)
- 12-729 Adapter has auxiliary pin in center of 6-Pole



11-932 T-Connector

- Adaptor for 5th Wheel & Bumper Mount Socket
- Quickly & Easily Installs a Second RV Socket
- Plug and Play without Splicing into OEM Harness
- Fits GM and Ford Trucks and SUV's
- Fits Chrysler Truck when used with 11-933 Adapter
- Mates with Pollak Socket 11-893



11-938 T-Connector

- T-Connector Kit with OEM style 11-893 Socket
- Adaptor for 5th Wheel & Bumper Mount Socket
- Same as 11-932 but includes OEM style 7-way Socket



Cable Assembly (Repairable)

14-117

Pollak® Plastic Trailer End
12-706 with 8 ft. of Cable.

14-116: same as 14-117
but with 3 ft. of Cable

14-227: Overmolded
Trailer End – RV Plug with
8' Harness



7 Way Harness Adapter

11-934

- US Car adapter snaps in place
- 3' Harness for easy wiring
- Protects warranty by leaving original OEM harness intact



Trailer Tow Accessories

Adapters



7 Way Pin Plug to **12-724**
7 Way RV Type Socket



12-411
4 Way Pin Plug to
4 Way Flat Flex Adapter



6 Way Round Plug to **12-725**
7 Way RV Type Socket



4 Way Flat Plug to **12-610**
6 Way Round Metal Socket



12-611
6 Way Round Male to 4 Way
Flat Female Flex Adapter



12-723
4 Way Flat Plug to
7 Way RV Type Socket



12-726
4 Way Flat Plug to
7 Way Round Metal Socket



12-625
6 Way Round Plug to
5 Way Flat Adapter



12-742
7 Way Pin Plug to
4 Way Flat Adapter



12-727: Nylon 7 way RV plug to 7 Way HD Socket
12-728: Nylon 7 Way RV Plug to Zinc 7 Way HD Socket

Testers

7 Pin Circuit



12-741 - 7 Way Blade
12-777 - 7 Way Round
(not shown)

4 Pin Circuit



12-410

Tail Light Converters

Heavy Duty 60"
12-750



Regular Duty 60"
12-751



12-752
3 Way to 2 Way
Converter (not shown)

SWITCHES

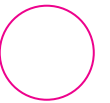
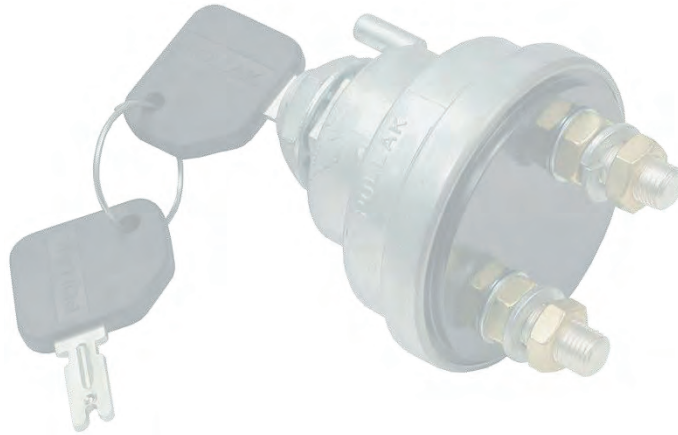

SWITCHES

50 AMPS 6-24 VOLT TOGGLE SWITCHES

Pollak® Toggle Switches designed for many high-current applications. Oversized internal copper contacts will carry up to 50 AMP current loads. Provides the longest possible service life. (Note: Quick-Connect Blade terminals will carry 30 AMPS.)

34-216
Standard
Chrome Handle
(Quick-Connect
Terminals)



34-220
Long Chrome
Handle #8-32
Screw Terminal

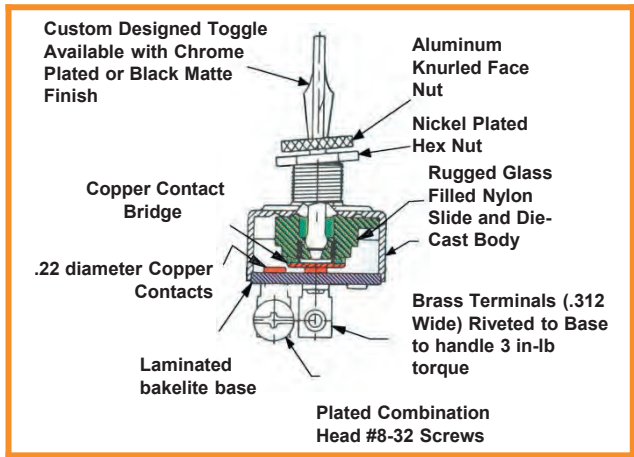

Part No.	Circuitry	No. of Terminals	Terminal Type	Handle Length	Handle Type	DC Volts	DC Amps
S.P.S.T (SINGLE POLE – SINGLE THROW)							
34-212	On-Off	2	Screw	Std. 1"	Chrome	12	50
34-213	On-Off	2	Screw	Long 1.5"	Chrome	12	50
34-216	On-Off	2	Blade	Std. 1"	Chrome	12	30
34-219*	On-Off	2	Screw	Std. 1"	Black	12	50
34-226*	On-Off	2	Blade	Std. 1"	Black	12	30
S.P.D.T (SINGLE POLE – Double THROW)							
34-225	On-On	3	Screw	Std. 1"	Chrome	12	50
34-218	On-Off-On	3	Screw	Std. 1"	Chrome	12	50
34-222*	On-Off-On	3	Screw	Std. 1"	Black	12	50
34-215	Mom On-Off-Mom On	3	Screw	Std. 1"	Chrome	12	50
34-223*	Mom On-Off-Mom On	3	Screw	Std. 1"	Black	12	50
34-220	Mom On-Off-Mom On	3	Screw	Long 1.5"	Chrome	12	50

* Available in E/EP versions only

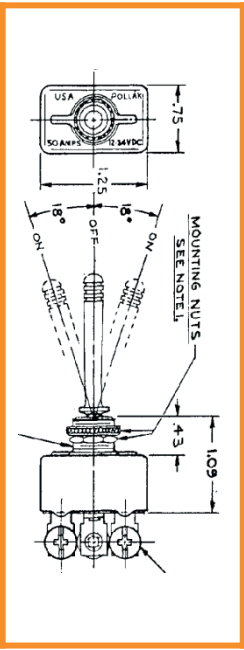

NYLON HANDLE DECORATOR STYLE 20 AMPS AT 12 VOLTS DC TOGGLE SWITCHES

Decorator style toggle switches designed with an O-Ring seal between toggle and bushing for splash proof reliability. Durable nylon housing, nylon face nut and brass terminals resist corrosion. Lighted versions have transparent Lexan handle. 20 AMPS @ 12 VDC.

34-586Q
.250 Blade
Terminals



34-586Q

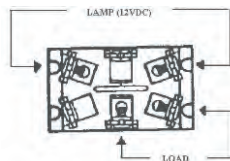

Part No.	Circuitry	No. of Terminals	Terminal Type	Handle Length	Handle Type
S.P.S.T (SINGLE POLE – SINGLE THROW)					
34-581Q	On-Off	2	Blade	Std. 11/16"	Black
34-586	On-Off	4	Screw	Std. 11/16"	Lighted

Q = Quick Connect .250 Terminals

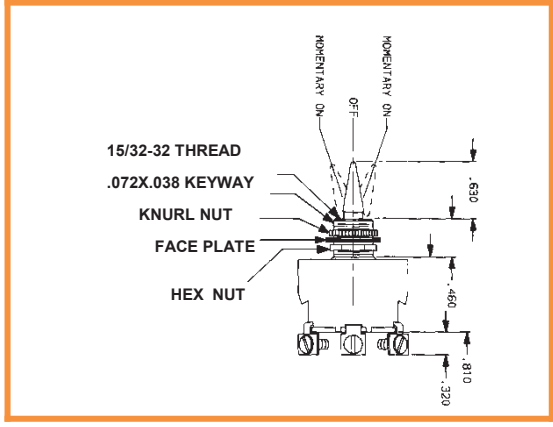

(See page 23 for Circuit Diagrams)

SWITCHES

A complete selection of circuitry configurations for Truck, Off-Road, Automotive and Recreational Vehicle applications. Provides durable and long lasting solutions to new and replacement requirements. 20 Amps @ 12 VDC.

Part No.	Circuitry	No. of Terminals	Terminal Type	Handle Length	Handle Type	Notes
S.P.S.T (SINGLE POLE – SINGLE THROW)						
33-302	On-Off	2	Screw	Std. 11/16"	Chrome	
34-571	On-Off	2	Screw	Std. 11/16"	Chrome	
34-571Q	On-Off	2	Blade	Std. 11/16"	Chrome	
34-571L	On-Off	2	Screw	Long 1.5"	Chrome	
34-571LQ	On-Off	2	Blade	Long 1.5"	Chrome	
34-579	On-Mom Off	2	Screw	Long 1.5"	Chrome	
34-579Q	On-Mom Off	2	Blade	Long 1.5"	Chrome	
34-570	Mom On-Off	2	Screw	Std. 11/16"	Chrome	
34-570Q	Mom On-Off	2	Blade	Std. 11/16"	Chrome	
S.P.D.T (SINGLE POLE – DOUBLE THROW)						
34-572	On-On	3	Screws	Std. 11/16"	Chrome	
34-572Q	On-On	3	Blade	Std. 11/16"	Chrome	
34-573	On-Off-On	3	Screw	Std. 11/16"	Chrome	
34-573Q	On-Off-On	3	Blade	Std. 11/16"	Chrome	
34-653	On-Off-On	3	3 Wire	Std. 11/16"	Chrome	Coated Leads
34-575	Mom On-Off-Mom On	3	Screw	Std. 11/16"	Chrome	
34-575Q	Mom On-Off-Mom On	3	Blade	Std. 11/16"	Chrome	
34-596	On-Off-Mom On	3	Screw	Std. 11/16"	Chrome	
D.P.S.T. (DOUBLE POLE – SINGLE THROW)						
34-574	On-Off	4	Screw	Std. 11/16"	Chrome	
34-574Q	On-Off	4	Blade	Std. 11/16"	Chrome	
D.P.D.T. (DOUBLE POLE – DOUBLE THROW)						
34-654	On - Off - On	6	6 wire	Std. 11/16"	Chrome	Coated Leads
34-576Q	On-On	6	Blade	Std. 11/16"	Chrome	
34-577	On-Off-On	6	Screw	Std. 11/16"	Chrome	
34-577Q	On-Off-On	6	Blade	Std. 11/16"	Chrome	
34-577LQ	On-Off-On	6	Blade	Long 1.5"	Chrome	
34-578	Mom On-Off-On	6	Screw	Std. 11/16"	Chrome	
34-578Q	Mom On-Off-On	6	Blade	Std. 11/16"	Chrome	
34-580	Mom On-Off-Mom On	6	Screw	Std. 11/16"	Chrome	
34-580Q	Mom On-Off-Mom On	6	Blade	Std. 11/16"	Chrome	
34-580L	Mom On-Off-Mom On	6	Screw	Long 1.5"	Chrome	
34-580LQ	Mom On-Off-Mom On	6	Blade	Long 1.5"	Chrome	
34-591Q	Mom On-Off-Mom On	4	Blade	Std. 11/16"	Chrome	Reversing
34-591LQ	Mom On-Off-Mom On	4	Blade	Long 1.5"	Chrome	Reversing
34-592	On-On	6	Screw	Std. 11/16"	Chrome	Reversing
34-592Q	On-On	6	Blade	Std. 11/16"	Chrome	Reversing
34-593LQ	On-Off-On	6	Blade	Long 1.5"	Chrome	DHP Circuits Headlamp Switch

Q = Quick Connect .250 Terminals L = Long Handle 1.5"

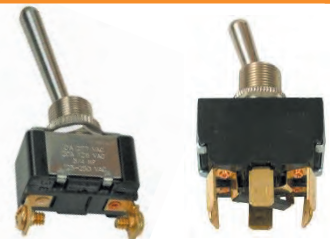
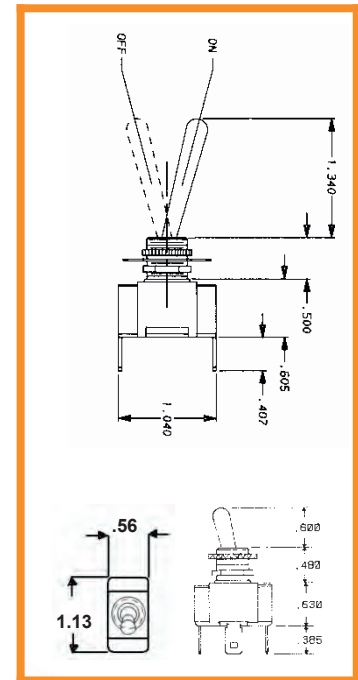

34-571L Long Handle Screw Terminals
34-592Q Jumper Blade Style

WIRING DIAGRAMS

34-591Q

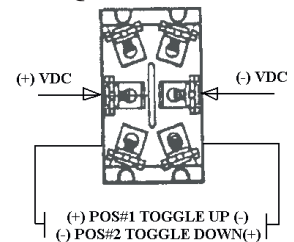

34-593Q

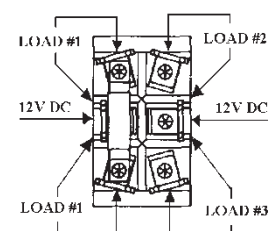

ACCESSORIES

The best combination of space-saving size and economy. Universal for Automotive, Light Truck, Off-Road and Recreational vehicles. Furnished with mounting hardware.

33-300

2 Position Toggle Switch, On-Off
6 Volt-35 Amps 12 Volt-20 Amps
Brass construction. Screw terminals.
Toggle and Face Nut CHROME
PLATED, Mounting Stem 3/8"
Long, 7/16" diameter



34-500

2 Position Toggle
Switch, 20 Amps @ 12
VDC, S.P.S.T. Knurled
Face Nut Indicator
Plate, Back Nut and
Terminal Screws
assembled.



25-371

1/2 Toggle Boot
Same as Toggle Boot #25-370 except allows
Toggle Handle (of any length) to protrude.
Accommodates all toggle lever diameters
from .155" - 240" including all Pollak toggles
except nylon handle series.



25-370

Toggle Boot with 15/32-32 thread. Provides
protection against salt spray and is resistant to
weather and ozone. Can be used on toggle
switches with 15/32" diameter mounting stem.



34-513

2 Position Toggle
Switch. 10 Amps @
12V



34-504

Face Plate On-Off



See Page 23 For Wiring
Diagrams, Terms and Tips.

UNIVERSAL DESIGN ROCKER SWITCHES - 20 AMPS AT 12 VDC

Universal Design for Automotive, Truck, Bus, Marine & Recreational Vehicles. Snap-in mounting fits .830 x 1.450 panel cutout in .093, .125, .187 thick panels. Brass screw or .250 blade terminals. Nylon bezel actuator and housing.

Internal and External Features

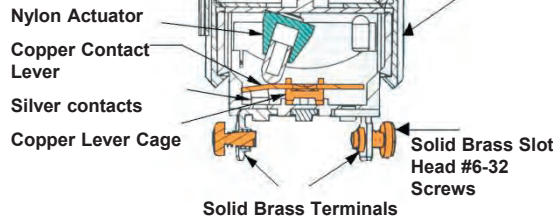

WIRING DIAGRAM 34-305

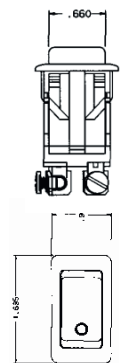
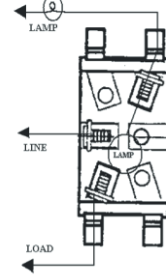

Part No.	Circuitry	No. of Terminals and Type	Actuator	Lens	Notes	Application
S.P.S.T. (SINGLE POLE – SINGLE THROW)						
34-301	On-Off	2 Screw	Black			Signaling Switch, Day
34-308	On-Off	2 Blade	Black			Signaling Switch, Day
S.P.S.T. (SINGLE POLE – SINGLE THROW) WITH PILOT LIGHT						
34-305	On-Off	3 Screw	Black	Red	Red Pilot Light	
34-360	On-Off	3 Blade	Black	Red	Red Pilot Light	
34-306	On-Off	3 Screw	Black	Green	Green Pilot Light	
34-307	On-Off	3 Screw	Black	Amber	Amber Pilot Light	
34-310	On-Off	4 Blade	Black	Red	Red Pilot Light	
D.P.D.T. (DOUBLE POLE – DOUBLE THROW)						
34-311	Off-On-On	4 Blade	Black			Two Speed Windshield Wiper
34-359	On-On	6 Blade	Black		Reversing	Selector Valves, Fans, Booms
D.P.D.T. (DOUBLE POLE – DOUBLE THROW) WITH DUAL CIRCUITRY						
34-312	High-Low-Off	6 Blade	Black		Dual Actuators High-Low-Off	

34-359



34-305

See Page 23 For Wiring Diagrams, Terms and Tips.

SWITCHES

SEALED ILLUMINATED ROCKER SWITCHES

**34-230
(Shown)**



- Designed for complete protection against dust and moisture.
- Rated 20 Amps at 12 VDC.
- Features include black plastic housing, nylon bezel, silver contacts, white lens with LED bulb, and .250" quick connect terminals.
- May be used with Pollak's new single and modular mounting brackets.

(Panel cut-out dimension: .83" W x 1.45" H)

34-230	On-Off, S.P.S.T	34-236	Mom. On-Off-Mom. On, S.P.D.T.
34-231	Mom. On-Off, S.P.S.T.	34-237	On-On, D.P.D.T.
34-232	Off-On-Off, S.P.S.T.	34-238	On-Off, D.P.S.T.
34-233	On-On, S.P.D.T.	34-239	Mom. On-Off-Mom. On, D.P.D.T.
34-234	On-Off-On, S.P.D.T.	34-240	Off-On-On, Progressive
34-235	On-On-On, S.P.3.T.	34-241	On-On-Mom. On, Progressive

ROCKER SWITCHES MOUNTING BRACKETS



- New Modular mounting brackets and single mounting bracket #34-260 (Not shown) for use with installing Pollak's® new rocker switches #34-230 Series (Shown above).
- To be used when installing rocker switches in panels.
- Stackable mounting end brackets #34-258 are reversible and can be connected to either side of middle bracket #34-259.
- Single mounting bracket #34-260 may be used for a single switch mount.

34-255	Panel Gasket Seal
34-258	Mounting Bracket End Piece
34-259	Mounting Bracket Middle Piece
34-260	Single Mounting Bracket

WEATHER RESISTANT TOGGLE SWITCH

34-571C



- Weather resistant plastic coating with O-Ring in stem.
- 2 Positions: On-Off, S.P.S.T., Rated 20 Amps, 12 VDC
- Knurled face nut, hex back nut, and 2 plastic coated wire leads 8" long.
- Chrome plated bat handle, mounting stem 15/32 diameter., 3/8" long.
- **34-111** Same as 34-571C except with 2 plastic coated wire leads 24" long.

TOGGLE SWITCH GUARD

34-508



- Spring loaded snap action holds the guard cover in the up or down position. Switch cannot be operated with the cover in the down position.
- Recommended for use with two position (Off-On or On-On) toggle switches with standard 11/16" bat handle and 15/32" diameter mounting stem and keyway.
- Face plate is steel with black glossy finish. Switch cover coated with red urea.

S.P.S.T. (Single Pole/Single Throw)

A two terminal switch which opens or closes one circuit.

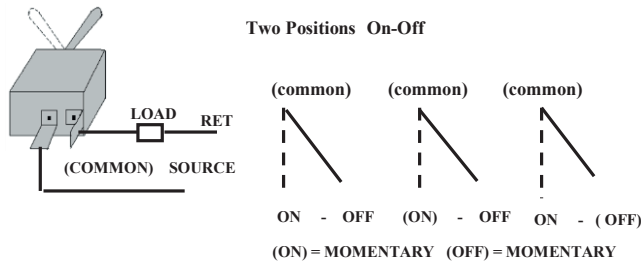

S.P.D.T. (Single Pole/Double Throw)

A three terminal switch that controls two single-wire circuits. Permits only one circuit to be energized at a time

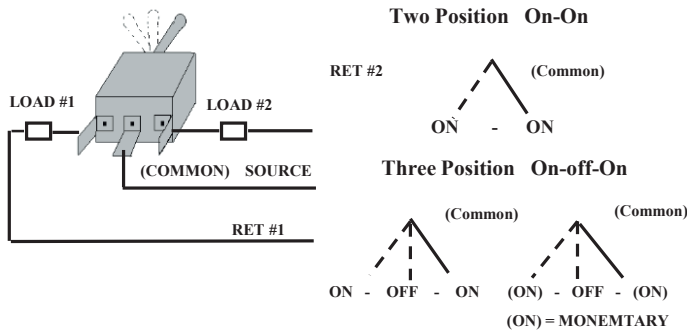

D.P.D.T. (Double Pole/Double Throw)

A six terminal switch that controls two double wire circuits permitting only one circuit to be energized at a time, or four single wire circuits permitting only two circuits to be energized at a time

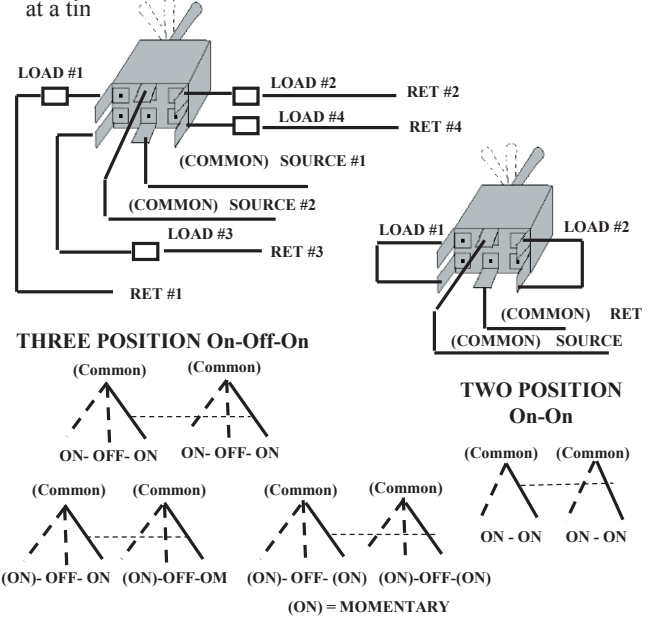

D.P.S.T. (Double Pole/Single Throw)

A four terminal switch that controls one double wire circuit or two single wire circuits.

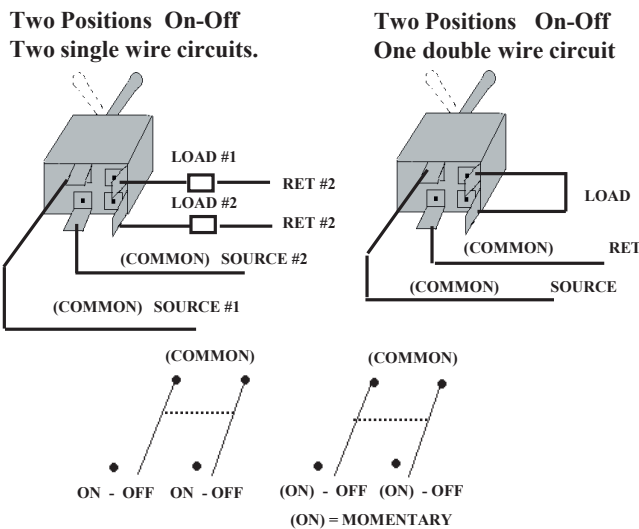

ELECTRICAL TERMS

- AMPERE** Electrical unit indicating rate of flow of electricity through a circuit.
- CIRCUIT** Path taken by electrical current flowing through conductor from one terminal source of supply to another.
- CURRENT** The movement of electrons through a conductor measured in amperes.
- DOUBLE POLE** A switch that operates simultaneously in two separate electric circuits.
- DOUBLE THROW** A switch that alternately completes a circuit at either end of its extreme positions.
- DOUBLE POLE/SINGLE THROW** D.P.S.T. - A switch that has four terminals and is used to connect or disconnect two pairs of terminals simultaneously.
- DOUBLE POLE DOUBLE/THROW D.P.D.T.** A switch that has six terminals and is used to connect one pair of terminals to either of the other two pairs.
- INDUCTIVE LOAD** Initial amps needed to engage a circuit and/or a load which allows a momentary flow of current when a circuit is open. {Devices that create inductive loads are typically motor coils and solenoids.}
- LAMP LOAD** Light bulb current expressed in amps at a rated voltage.
- MOMENTARY** Momentary action is obtained by holding switch in position with pressure. Upon release the switch returns to the previous position.
- REVERSING** Reversing action is obtained by reversing the polarity of a switch with jumper wires or blades to change the rotation of a motor. Typical applications are winches, plows, radio antennas and fuel selector valves.
- SINGLE POLE** A switch that opens, closes, or changes connection in a single conductor of an electrical circuit to a common contact.
- SINGLE THROW** A switch that opens, closes or completes a circuit at only one of the extreme positions of its actuator.
- SINGLE POLE/SINGLE THROW** S.P.S.T. - A two terminal switch which opens or closes one circuit.
- SINGLE POLE/DOUBLE THROW** S.P.D.T. - A three terminal switch for connecting one terminal to either of two other terminals.
- VOLT** The unit that measures the potential difference in electrical force or "pressure" between two points on a circuit.
- WATT** The unit of power that indicates the rate at which a device converts electric current to another form of energy, either heat or motion.

SERVICE TIP

- Replacement switch must have the same or higher rating as original switch.
- Unplug circuit or turn off power at electrical panel.
- Remove wires from old switch one-at-a-time and attach to new switch in same manner, or follow wiring diagram.
- For Screw Terminals - Twist stranded wire together. Loop wire clockwise around screw. Tighten securely.
- For Blade Terminals - Use Female push-on terminals. Crimp tightly on stranded wire. Make sure you have a snug fit.
- Turn on power

SWITCHES - PUSH-PULL

35-331
Same as 35-306
with Red Metal
Knob

35-330
Same as 35-306
with Black Metal
Knob

35-319
Same as 35-306
except the hardware
is assembled on the
switch.



35-306
6-28 VOLTS - 75 AMP D.C.
2 POSITION S.P.S.T. OFF-ON
Die-Cast Body, CHROME PLATED,
Knob, Copper Terminals, Mounting Stem
5/8" long, 15/32" Diameter

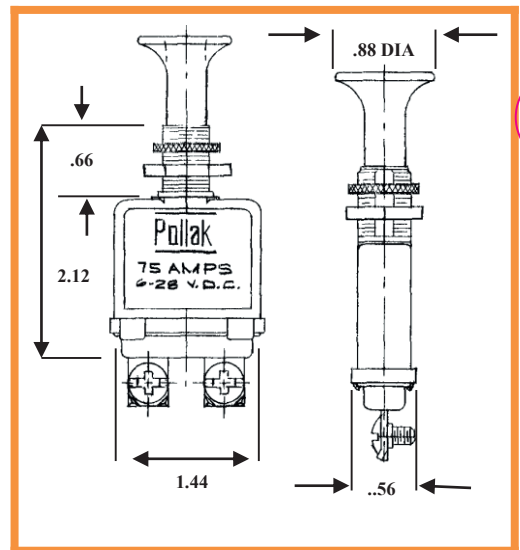

35-335



35-335
12 VOLTS - 50 AMP D.C.
2 POSITION S.P.S.T. OFF-ON
Green LED – lighted in on position

35-334



35-334
12 VOLTS - 30 AMP D.C.
2 POSITION S.P.S.T. OFF-ON

35-333



35-333
12 VOLTS - 30 AMP D.C.
3 POSITION OFF-ON-ON
Two separate circuits

35-320



52-642
Mating Connector

2 Position Off-On (Normally Off) –
One Circuit. Rugged Nylon
housing and mounting bracket.
Bushing .59" long, .59 diameter
Silver plated brass terminals mate
with Mating Connector #52-642.
Panel mount or transmission shaft
mount (when used as a single speed
axle switch)

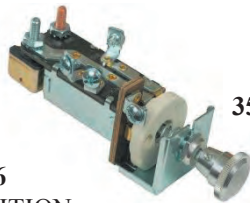

35-316

35-316
3 POSITION
12V OFF-ON-ON Combination
Rheostat, Panel and Headlight. Push
Pull for Headlights, Turn to Dim
Panel. With 20 Amp Circuit Breaker, 5
Terminals, Bright Metal Knob,
Mounting Stem 3/8" Long, 3/8"
diameter.

MARINE

33-400
3 POSITION
OFF-ON-BOTH ON FOR
CONTROLLING RUNNING
LIGHTS, etc. Large 3/4"
diameter. Face Nut of
POLISHED CHROME.
Brass Back Nut and Washer.
CHROME PLATED plastic
knob. Mounting Stem
1-1/4" Long 7/16" diameter.



33-400

33-402
2 POSITION 25 Amps at 6V
15 Amps at 12V
OFF-ON POLISHED
CHROME Face Nut and
CHROME PLATED plastic
knob. Brass Back Nut and
Washer. Mounting Stem
1-1/4" Long, 3/8" diameter.

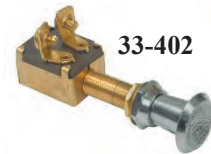

33-402

33-403

3 POSITION
OFF-ON-ON Two Separate Circuits.
Brass Back Nut and Washer.
BRASS CHROME PLATED Knob
and Face Nut. Mounting Stem 1-1/4"
Long, 3/8" diameter.



33-403

35-300
2 POSITION
OFF-ON 25 Amp at 6V
15 Amps at 12V. Mounting Stem 5/8"
Long 7/16" diameter. Ivory Plastic Knob.



35-300

SWITCHES

MOMENTARY PUSH SWITCHES

FOR TRUCKS, TRACTORS, FARM, MARINE, INDUSTRIAL APPLICATIONS – POPULAR FOR DIESEL STARTING
Momentary push-button switches function by having an operator push the plunger to make electrical contact. When the actuating force is removed, the plunger returns to the original position, breaking the electrical contact.

Momentary Push Switches 2 Positions – OFF-On, Normally OFF (Push to On)

Zinc Die-Cast Housing, Silver
Contacts, Brass Terminals.

Operation: 50,000 Cycles
Mounting stem: 5/8-32 Thread
Accommodates panels up to 1/4"
thick.

Contact Rating:

@ 14VDC: Make 70 Amps, Break 20 Amps Inductive Load
@ 28 VDC: Make 35 Amps, Break 10 Amps Inductive Load

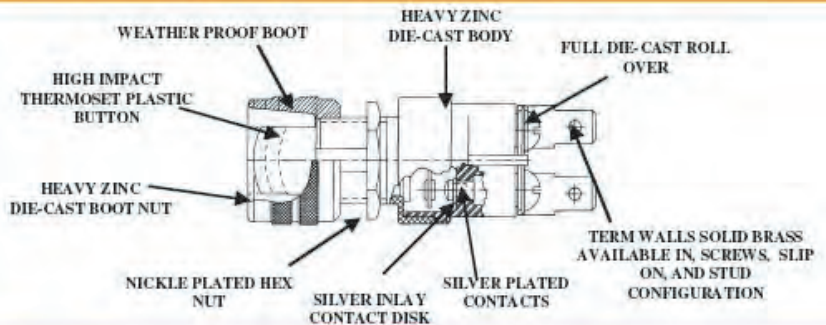

24-359 –

- Silver-plated contacts
- Flush terminal screws in molded insulator
- Housing rolled over insulator to seal out Dust and Moisture
- Hex Back Nut
- Bright Polished Face Nut
- Black Molded Plunger
- Mounting Stem 5/8" Long, 5/8" Diameter Thread
- Overall Length 1-13/16"
- Housing diameter 15/16"

24-360 – WEATHER AND DUSTPROOF. Same as #24-359 except with #25-358 Cap and Face Nut, to seal out Weather and Dust.

24-362 - (Not Shown). Same as #24-359 except with #25-372 Protection Collar.

24-363 - (Not Shown) Same as #24-392 except with #25-358 black rubber boot.

24-373 - (Not Shown) Same as #24-359 except with 2 Male Blade "quick connect" terminals.

24-391 – (Not Shown). Same as #24-392 except without hex face nut.

24-390 – (Not Shown). Same as #24-359 except for hex nut thickness.



24-392 - Same as #24-359 except with brass turret /button terminals. (Mates with Packard Connector #2973407)



24-394 Same as #24-359 except with black face nut and 3/8" long #8-32 threaded terminals. (Freightliner, Navistar)

24-393 - Same as #24-394 except with #25-358 back rubber boot. (Not Shown)

24-395 - Same as #24-393 except with #25-352 red rubber boot.

24-372 - SWITCH - Same as #24-359 except with special design features ... Brass, chrome plated protection collar P/N #25-372 prevents accidental start. Combination screw and 1/4 male blade terminal with locking hole will accept Packard #2962447 terminal and #2977253 connector or equivalent. Replaces GM Switch #2067912. Mounting stem 5/8" long, 5/8" diameter. overall length 1 13/16".



SWITCHES

BOOT NUT ASSEMBLIES

WEATHER and DUSTPROOF Neoprene rubber type Boot Nut Assemblies. With 5/8-32 thread, Can be used on #52-611 and #33-200 and on other Momentary Switches with this Mounting Stem

25-372



Protective Collar - Safety Bezel with 5/8"-32 thread may be used on #24-359, #52-611, #33-200 and on other momentary switches with this mounting stem.

25-358
Black



25-351
Same as 25-358 except with recessed "horn" symbol.

25-350



Yellow boot with recessed "cold start" symbol.

25-352
Red



25-349
Same as 25-352 except with recessed "start" symbol.

52-611



Universal-Mounting Bushing 3/4" Long, 5/8" diameter. Hex Pal Back Nut knurled Face Nut assembled. 25 AMPS @ 6V, 15 AMPS & 12V. Mounts in 5/8" diameter hole.

52-613



Same as 52-611 except with 25-358 boot nut and PVC coated body for weather and dust protection. 14" wire loop.

52-600



REPLACES: 21A11500A, Screw Terminals. 15 AMPS @ 6V, 10 AMPS @ 12V, 15/16" Mounting Hole Required. Mounting Stem 7/8"-20, .45" long. Supplied with 7/8"-20 palnut.

MOMENTARY SWITCHES

2 Positions: On- Off Normally On (Push to Off)



21-541

Momentary Switch -Normally On (Push to Off). Moisture Proof with two 6" 16 gauge wire leads with Packard Electric Connector #12010973. Mates with Packard #12015792.

21-560

Same as 21-541 except Normally Off (Push to On). Mates with Packard # 15300027

SEALED PLUNGER SWITCHES

2 Positions: On- Off
Normally On (Push to Off)



52-624

Sealed Plunger Switch #52-620 and Mating Connector #52-622. 10 Amps at 14V. Self tapping thread. Self-Adjusting, Switch length 2 1/8". Mating connector has three 8" 18 gauge wire leads.

MARINE

15 Amps at 12V



33-200

ALL BRASS, CHROME PLATED Button and Face Nut Furnished. Brass Back Nut and Washer Mounting Stem 1 1/4" Long 5/8" diameter. 25 Amps @ 6V. Fits 1" thick panel.



52-623

Door Jamb Switch to accept two Bullet terminals. 5 Amps at 12V. REPLACES: Ford OA1-13713, BOA-13713, B9MF-13713A, C3AZ-13713A.

PRECISION BALL SWITCHES

As the leading manufacturer of precision ball-actuated switches, Pollak® has provided custom switches to meet the requirements of OEM's and aftermarket suppliers. Typical applications include: neutral and top gear sensing, back-up lamp switching, anti-lock brake switching, power take-off interlock and operator presence detecting. The switches shown here represent the transportation industry's most commonly requested configurations. If the switch you need cannot be found on these charts, please contact us for your specific requirements.

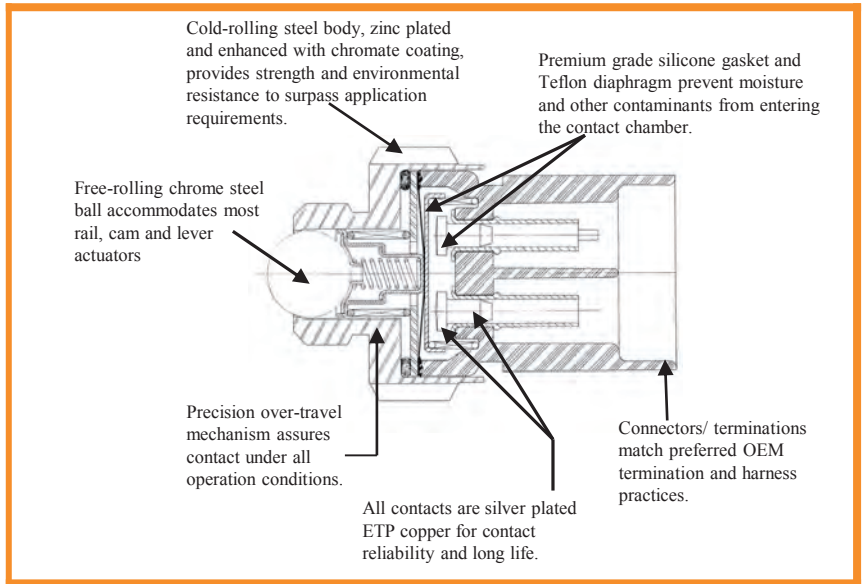

CHARACTERISTICS:

- Normally Open - Exposed Terminals



21-458
Screw Terminals



21-481
Turret Terminals

Part No.	Thread	Hex	Free Position	Make/Break	Connector Terminals	Mating Connector	Special Features
21-361	9/16-18	7/8	.421 / .416 (10.69-10.57)	.406 / .391 (10.31-09.93)	Stud Terminals		
21-381	9/16-18	7/8	.765 / .760 (19.43-19.30)	.730 / .715 (18.54-18.16)	Turret Terminals		
21-458	9/16-18	7/8	.421 / .416 (10.69-10.57)	.408 / .390 (10.36-09.93)	Screw Terminals	Ring Terminals	
21-481	9/16-18	7/8	.421 / .416 (10.69-10.57)	.408 / .390 (10.36-09.93)	Turret Terminals	PE 02973407	
21-487	9/16-18	7/8	.421 / .416 (10.69-10.57)	.408 / .390 (10.36-09.93)	Screw Terminals	Ring Terminals	21-458 with O-Ring
21-509	3/4-16	7/8	.577 / .551 (14.15-14.00)	.533 / .513 (13.54-13.03)	Screw Terminals		

CHARACTERISTICS:

- Normally Closed - Exposed Terminals

21-456
.250 Blade Terminals



21-517
.250 Blade Terminals



Part No.	Thread	Hex	Free Position	Make/Break	Connector Terminals	Mating Connector	Special Features
21-434	9/16-18	7/8	.421 / .416 (10.69-10.57)	.408 / .390 (10.36-09.93)	Turret	PE 02973407	
21-435	9/16-18	7/8	.421 / .416 (10.69-10.57)	.408 / .390 (10.36-09.93)	Screw	Ring Terminals	
21-437	9/16-18	7/8	.421 / .416 (10.69-10.57)	.408 / .390 (10.36-09.93)	Screw	Ring Terminals	Plating
21-448	3/4-16	7/8	.606 / .601 (15.39-15.27)	.600 / .384 (15.24-14.86)	Screw	Ring Terminals	Aluminum Washer resist Corrosion
21-456	9/16-18	7/8	.421 / .416 (10.69-10.57)	.408 / .390 (10.36-09.93)	.250 Blade	Rect. Receptacle Term	
21-517	9/16-18	7/8	.421 / .416 (10.69-10.57)	.408 / .390 (10.36-09.93)	.250 Blade	Rect. Receptacle Term	21-456 With O-ring

CHARACTERISTICS:

▪ Normally Open - Sealed Terminals

21-370



Part No.	Thread	Hex	Free Position	Make/Break	Connector	Mating Connector	Special Features
21-363	9/16-18	7/8	.421 / .416 (10.69-10.57)	.406 / .391 (10.31-09.93)	Packard 56 Series	029S4092	
21-364	9/16-18	7/8	.421 / .416 (10.69-10.57)	.408 / .390 (10.36-09.93)	Ford Automotive Type	C0AF-14A121-A	
21-370	9/16-18	7/8	.421 / .416 (10.69-10.57)	.406 / .391 (10.31-09.93)	Packard Weather Pack	12015792	
21-400	9/16-18	7/8	.421 / .416 (10.69-10.57)	.408 / .390 (10.36-09.93)	Ford Automotive Type	E2EB-14A464-AB	
21-443	M14*1.5	M22	.460 / .450 (11.68-11.43)	.435 / .415 (11.05-10.54)	Ford Automotive Type	D6ZB-14A336-BA	Teflon Tape Thread Sealant
21-465	9/16-18	7/8	.421 / .416 (10.69-10.57)	.406 / .391 (10.31-09.93)	Packard Metri-Pack	12052644	
21-491	5/8-18	7/8	.433 / .417 (11.00-10.59)	.405 / .380 (10.29-09.65)	Packard Weather Pack	12103784	
21-492	M14*1.5	M22	.577 / .567 (14.66-14.40)	.561 / .543 (14.25-13.79)	Packard Metri-Pack	12052644	
21-532	9/16-18	7/8	.421 / .416 (10.69-10.57)	.406 / .391 (10.31-09.93)	Packard Weather Pack	12015792	Teflon Tape Thread Sealant
21-595	M16*1.5	7/8	.980 / .970 (24.89-24.64)	.960 / .945 (24.38-24.00)	Packard Weather pack	12015792	Teflon Tape Thread Sealant

CHARACTERISTICS:

▪ Normally Closed - Sealed Terminals

Part No.	Thread	Hex	Free Position	Make/Break	Connector	Mating Connector	Special Features
21-444	5/8-18	7/8	.433 / .417 (11.00-10.59)	.405 / .380 (10.29-09.65)	Packard Weather Pack	12103784	
21-495	9/16-18	7/8	.657 / .652 (16.69-16.56)	.644 / .625 (16.36-15.88)	Packard Weather Pack	12015792	Assembled with O-Ring
21-538	M16*1.5	M22	.609 / .598 (15.47-15.19)	.594 / .579 (15.09-14.71)	Packard Weather Pack	12103784	

CHARACTERISTICS:

▪ Normally Open - Encapsulated with Wire Leads

Part No.	Thread	Hex	Free Position	Make/Break	Connector	Mating Connector	Special Features
21-467	9/16-18	7/8	.421 / .416 (10.69-10.57)	.408 / .390 (10.36-09.93)	Packard Metri-Pack	15300027	
21-493	M14*1.5	M22	.577 / .567 (14.66-14.40)	.561 / .543 (14.25-13.70)	Packard Metri-Pack	12052644	
21-562	9/16-18	7/8	.421 / .416 (10.69-10.57)	.406 / .391 (10.31-09.93)	Packard Metri-Pack	15300027	

CHARACTERISTICS:

▪ Normally Closed - Encapsulated with Wire Leads



21-478

Part No.	Thread	Hex	Free Position	Make/Break	Connector	Mating Connector	Special Features
21-478	9/16-18	7/8	.421 / .416 (10.69-10.57)	.408 / .390 (10.36-09.93)	Packard Weather Pack	12010973	
21-482	9/16-18	7/8	.421 / .416 (10.69-10.57)	.408 / .390 (10.36-09.93)	Packard Weather Pack	12010973	Assembled with O-Ring
21-547	9/16-18	7/8	.421 / .416 (10.69-10.57)	.408 / .390 (10.36-09.93)	Packard Metri-Pack	15300002	Assembled with O-Ring

IGNITION STARTER SWITCHES

Momentary Start Universal Type Die-Cast Housing

COMMON AVAILABLE SWITCH CHARACTERISTICS

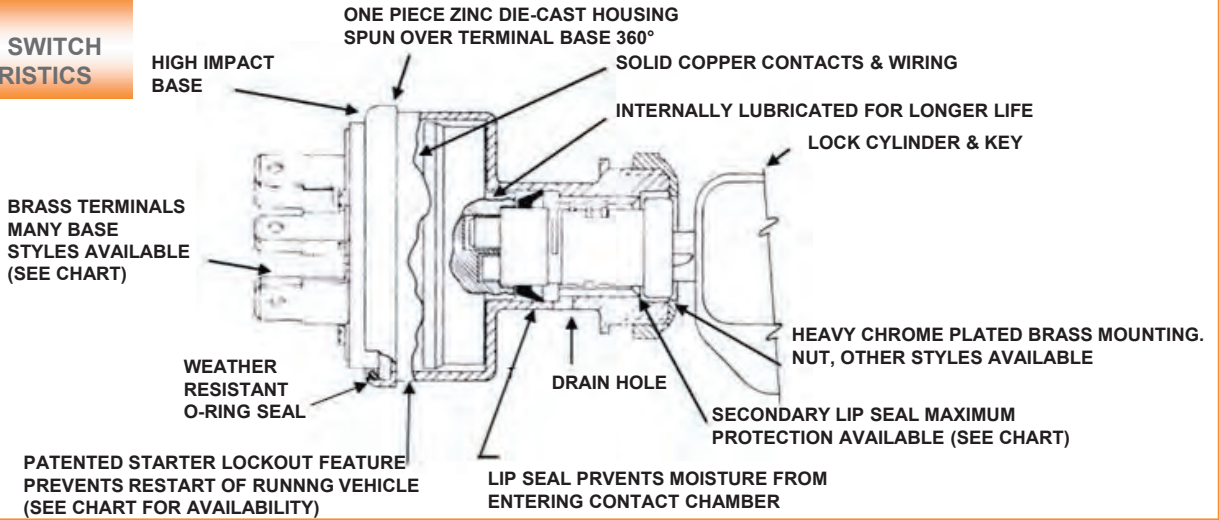

BASE TYPES & CONNECTIONS



For Specific Applications Consult Factory

Base Types (3, 3A & 7) fit Packard Connector #2984017

Typical Ratings @ 14 Volts DC (50,000 Cycles)

Ignition Terminal	Accessory Terminal	Start Terminal
8 Amps	30 Amps (Inductive)	75 Amps make 20 Amps Break

Continuous Current Carrying Capacity – 30 Amps @ 14V. Accessory Terminal with #10 Gauge Wire.

For Specific Applications Consult Factory

MOUNTING HOLE PATTERNS

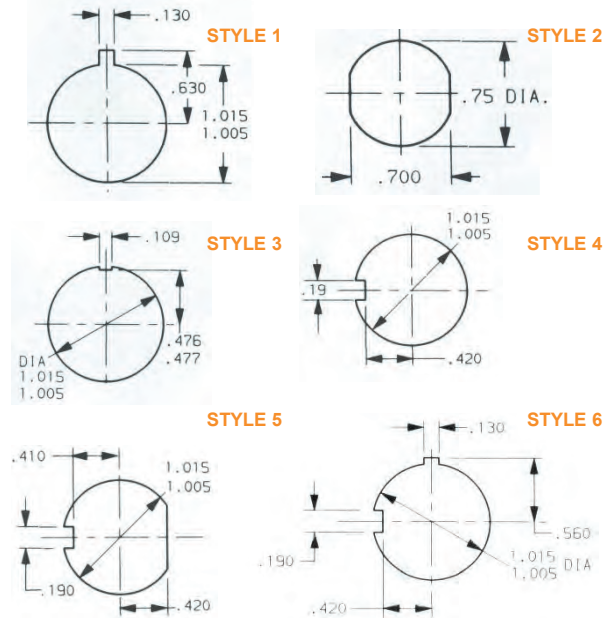

4-POSITION SWITCHES

FUNCTIONS & POSITIONS

Key Removable in "Off" Position Only

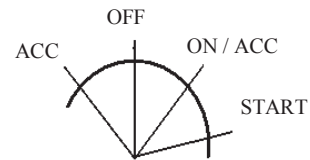

(SPRING RETURN TO ON)

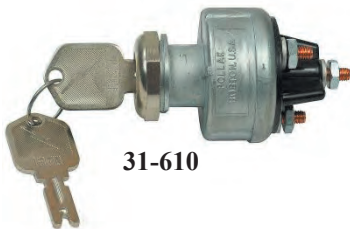

31-610

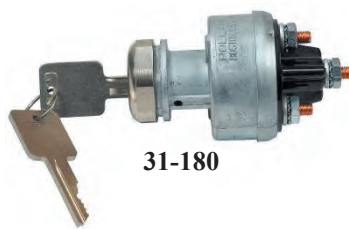

31-180

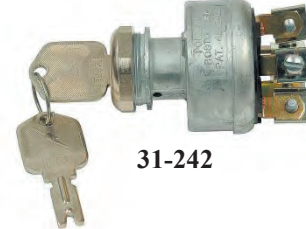

31-242

Base Type	Part No.	Starter Lockout	Key Logo	Key code	# of Lip Seals	M/H/P	Remarks
1	31-103	N	Pollak	Various	0	2	
1	31-104	N	Pollak	PK556	0	2	
1	31-105	Y	Pollak	Various	0	2	
1	31-106	Y	Pollak	PK556	0	2	
1	31-109	N		No L/Cyl	0	1	No Base Hardware Supplied
1	31-110	N	Pollak	Various	0	1	No Base Hardware Supplied
1	31-111	N		No L/Cyl	0	1	No Base Hardware Supplied
1	31-131	N	Pollak	Various	0	1	Spc. Hardware Clips
1	31-159	N	None	Special	1	3	Key Code 31-159-100
1	31-178	N	L/Cyl Mfg	D250	2	5	
1	31-180	N	L/Cyl Mfg	Various	2	5	"O" Sealed Base
1	31-190	N	No Key	Universal	1	4	No Base Hardware or Keys Supplied
1	31-196	N	Pollak	Universal	1	4	
1	31-233	Y		No L/Cyl	0	2	
1	31-292	Y	Pollak	Various	0	2	Black Mounting Nut
1	31-292-801	Y	Pollak	C801	0	2	Black Mounting Nut
1	31-292-802	Y	Pollak	C802	0	2	Black Mounting Nut
1	31-292-803	Y	Pollak	C803	0	2	Black Mounting Nut
1	31-292-804	Y	Pollak	C804	0	2	Black Mounting Nut
1	31-292-805	Y	Pollak	C805	0	2	Black Mounting Nut
1	31-292-806	Y	Pollak	C806	0	2	Black Mounting Nut
1	31-305	Y	L/Cyl Mfg	D250	2	5	
1	31-607	N	Lever		0	2	
1	31-608	Y	Lever		0	1	
1	31-610	Y	Pollak	Universal	1	4	
2	31-124	N		No L/Cyl	0	3	Spc. Hardware Clips
3	31-228	N	Pollak	Universal			Terminal Ground ID Tag
2	31-242	Y	Pollak	Universal	1	4	Spc. Hardware Clips
3	31-132	N	L/Cyl Mfg	Various	0	Spc.	Bezel Mfg.

M/H/P = Mounting Hole Pattern

4-POSITION SWITCHES

FUNCTIONS & POSITIONS

Key Removable in "Off" Position Only

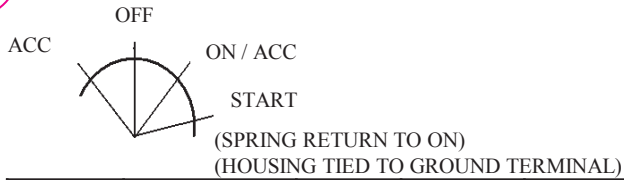

Base Type	Part No.	Starter Lockout	Key Logo	Key code	# of Lip Seals	M/H/P	Remarks
1	31-527	N	Pollak	D250	2	*	Spring return aux. / glow plug warmer
1	31-537	N	Pollak	Lever	2	*	Spring return aux. / glow plug warmer
2	31-112	N	Pollak	PK556	0	2	Special Hardware Clips
2	31-257	Y	L/Cyl Mfg	D250	1	5	O-Ring Sealed Base, Spc. Hdw Clip
3	31-114	N	Pollak	Various	0	1	Caution Tag on GND Term
3	31-152	N		No L/Cyl	0	1	Caution Tag on GND Term
3	31-229	N	L/Cyl Mfg	D250	2	5	
3	31-243	Y	Lever		1	5	
3	31-249	N	Pollak	PK556	0	1	Caution Tag on GND Term
3	31-289	N		No L/Cyl	0	1	Caution Tag on GND Term
3A	31-290	Y	L/Cyl Mfg	D250	1	5	O-Ring Sealed Base
3A	31-322	Y	Encap key	D250	1	5	No Logo on Encap keys
3	31-498-01	N	None	Various	0	3	Supplied with high durability double cut L/Cyl & keys
3A	31-139	N	L/Cyl Mfg	Various	0	Spc.	Bezel Mtg
3A	31-191	Y	L/Cyl Mfg	Various	1	5	O-Ring Sealed Base
3A	31-231	Y	L/Cyl Mfg	D250	1	5	O-Ring Sealed Base
3A	31-273	N	L/Cyl Mfg	Various	2	5	O-Ring Sealed Base
3A	31-280	N	None	Various	1	5	O-Ring Sealed Base, Mtg Nut Sold Separately
3	31-359	N	None	Various	0	3	

* - Mounting hole pattern similar to MHP style 5 without key way.

3-POSITION SWITCHES

FUNCTIONS & POSITIONS

Key Removable in "Off" Position Only

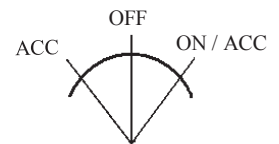

Base Type	Part No.	Starter Lockout	Key Logo	Key code	# of Lip Seals	M/H/P	Remarks
1	31-119	N		No L/Cyl	0	1	Extra Long Studs in all Positions
1	31-122	N	Pollak	C805	0	1	No Base Hardware Supplied
1	31-192	N		No L/Cyl	0	1	No Base Hardware Supplied
1	31-245	N	L/Cyl Mfg	D250	2	5	No Base Hardware Supplied, O-Ring Sealed Base
3	31-164	N		No L/Cyl	0	3	Mtg. Nuts Sold Separately
4	31-600	N	Pollak	Various	0	.75" D	
4	31-601	N	Pollak	PK556	0	.75" D	

Base Types (3, 3a & 7) fit Packard Connector #2984017

M/H/P = Mounting Hole Pattern

3 POSITION SWITCHES

FUNCTIONS & POSITIONS

Key Removable in "Off" Position Only

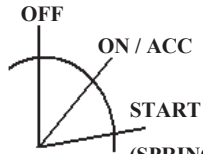

(SPRING RETURN TO ON)
(HOUSING TIED TO GROUND TERMINAL)



Base Type	Part No.	Starter Lockout	Key Logo	Key code	# of Lip Seals	M/H/P	Remarks
*	31-267	Y	L/CYL Mfg	D250	1	5	Black Mounting Nut, 4 Screw Terminal Base
2	31-302	Y	Pollak	Universal	1	5	
2	31-345	N	Pollak	Universal	1	4	
3A	31-285	N	L/CYL Mfg	D250	2	5	O-Ring Sealed Base
3A	31-297	Y	Pollak	Universal	1	4	

Base Types (3, 3A & 7) fit Packard Connector #2984017

M/H/P = Mounting Hole Pattern

3 POSITION SWITCHES

FUNCTIONS & POSITIONS

Key Removable in "Off" Position Only

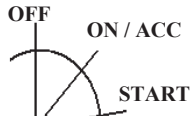

(SPRING RETURN TO ON)

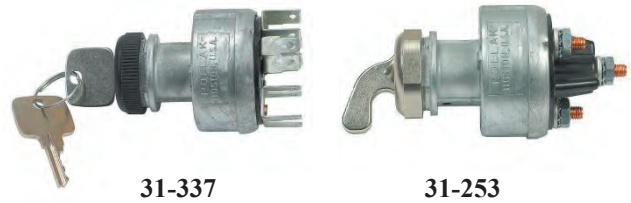

Base Type	Part No.	Starter Lockout	Key Logo	Key code	# of Lip Seals	M/H/P	Remarks
1	31-253	N	Lever	none	1	5	O-Ring Sealed Base
1	31-609	N	Blank	Various	0	2	
*	31-309	Y	L/CYL Mfg	D250	1	5	10 Blade Terminal, No Ground Pin
3	31-337	Y	Pollak	D250	1	5	
7	31-223	Y	Lever		0	5	Special PROOF terminal

Base Types (3, 3A & 7) fit Packard Connector #2984017

M/H/P = Mounting Hole Pattern

BASE TYPES

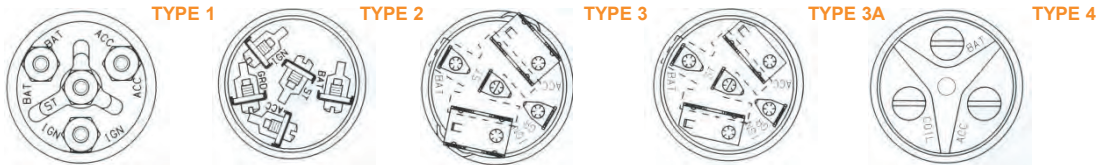

MOUNTING HOLE PATTERNS

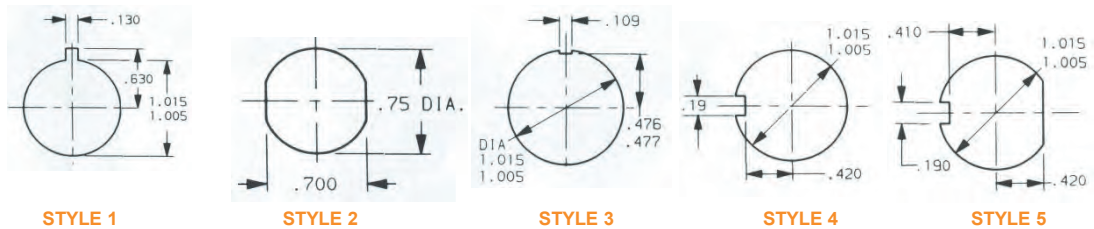

2-POSITION SWITCHES

FUNCTIONS & POSITIONS

Key Removable in "Off" Position Only

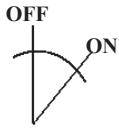

31-604

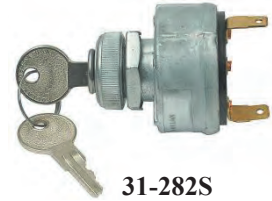

31-282S

Base Type	Part No.	Starter Lockout	Key Logo	Key code	# of Lip Seals	M/H/P	Remarks
5	31-288	N	Pollak	PK580	0	2	
5	31-602	N	None	Various	0	.75"D	
5	31-603	N	Pollak	PK556	0	.75"D	
5	31-604	N	Lever		0	.75"D	
6	31-117	N		No L/Cyl	0	2	
6	31-282S	N	Pollak	PK556	0	2	

M/H/P = Mounting Hole Pattern

BASE TYPES



TYPE 5



TYPE 6

MOUNTING HOLE PATTERNS

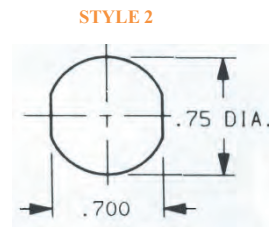

STYLE 2

MARINE STARTER SWITCHES - (for Magneto applications)

Magneto grounded in "Off" Position. Glass filled Delrin Housing, Stainless Steel Terminals. Molded Velox Base. 13/16" Diameter Mounting Bushing. Special weather proofing seal and drain hole. Furnished with Terminal Hardware, Mounting Nuts and Two Keys.

RATING @ 12 VDC
M-M Grounded-10 Amps Inductive
B-A 5 Amp
B-S 10 Amp
B-C 1 Amp (33-105 Only)

OFF (MAGNETO GROUNDED)

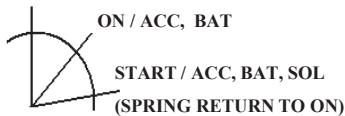

33-104

Special long bushing allows mounting in panels up to 1 1/4" thick. Replaces - Johnson-Evinrude Numbers 386496, 379047, 378238.

33-107

Same as 33-104 except all switches keyed alike. (Key #:33-150-101-31)

33-150-100 - blank key for 33-104/107/150

OFF (MAGNETO GROUNDED)

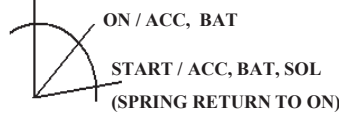

33-105

Special "Push to Choke" feature eliminates need for separate Electronic Choke Switch. Switch mounts in panels up to 1/4" thick. Replaces - Johnson-Evinrude Numbers 388173, 390129, 390133.

PUSH TO CHOKE FEATURE

OFF (MAGNETO GROUNDED)

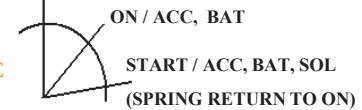

33-150

Delrin, Stainless Steel, 6 terminals, special weather-proofing seal and drain holes. Furnished with face nut and brass screws. Various key changes for security. Mounting bushing 1 1/4" thick. Length = 1/2" long. Switch mounts in panels up to 1/4" thick Replaces Johnson-Evinrude numbers 386496, 379047 and 378238.

IGNITION STARTER SWITCHES

(Special Applications)

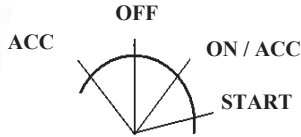

31-527

SPECIAL 4 POSITION IGNITION SWITCH

Specially designed with glow plug 'warm' position.

31-537

SPECIAL 4 POSITION IGNITION SWITCH

Same as 31-527 except with lever. Specially designed with glow plug 'warm' position

31-499

SPECIAL (HI POWER) IGNITION SWITCH

Ratings at 14VDC

- Ign - 15 Amps (8 Amps, standard)
- Acc - 40 Amps Continuous (30 Amps Standard)
- Start - 75 Amp Make, 20 Amp Break (Standard)

Unique Features

- Silver Plated Contacts
- Silver Plated Wiper Heat Dissipating Contact Connections
- Enhanced features available in Standard Envelope.

52-800



52-800

SPECIAL Rotary Reversing Switch

12 Volt 50Amp DC
3 Position On-Off-On



31-499

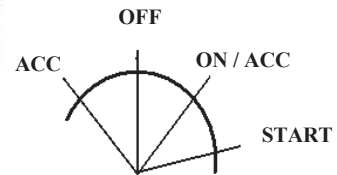

REPLACEMENT KEYS



31-332



31-166-001



31-600-103



31-339



31-159-001

D-250 Series

19564, Coined, 2 keys per ring. Replacement key for 31-178, 31-229, 31-231, 31-245, 31-257, 31-267, 31-285, 31-290, 31-305, 31-309, 31-322, 31-324, 31-337

Universal key Series

31-166-001, Coined, 2 keys per ring (Pollak Logo & Lightning Bolt)
31-332, Encapsulated, (Pollak Logo), 2 keys per ring
31-339, Encapsulated, (No Logo), 2 keys per ring
 Replacement keys for 31-190, 31-610, 31-242, 31-175, 31-302, 31-345, 31-297

(Unless otherwise noted, all keys sold individually.)

PK Series

31-600-103 (PK556), Coined, 2 keys per ring (Pollak Logo) Replacement keys for 31-104, 31-106, 31-112, 31-249, 31-282S, 31-603

31-173-104, blank key, Coined, Blank replacement keys for 31-132, 31-139, 31-180, 31-191, 31-272, 31-280

31-159-001 Replacement keys (2 per ring) for part No. 31-159

33-150-100 Blank replacement key for Part No. 33-104, 33-107 & 33-150

33-237-100 Blank replacement key for Part No. 33-105

SWITCHES

BATTERY MASTER DISCONNECT SWITCHES

Master disconnect switches designed for 12 VDC vehicles (Truck, Automotive, Marine, RV) to disconnect all circuitry to reduce possibility of theft or accidental electrical fires. Available in keyed or lever versions, with or without indexing pins, and various sizes of terminal studs.

51-902EP LEVER OPERATED 6-36 VDC 180 AMPS CONTINUOUS CAPACITY 1000 AMPS IN RUSH S.P.S.T. (OFF-ON) TWO STUD TERMINALS

For battery circuit only. Does not disconnect alternator or generator field circuit. On vehicles equipped with alternators/engine must be shut off to avoid potential damage to alternator diodes. (See 51-904EP)

- Individually Sealed Contacts
- One piece die-cast housing sealed with O-rings at base and mounting stem to keep out dust and moisture.
- Large die-cast, lever for ease of operation.
- Two 3/8" copper alloy stud terminals with hex nuts and lock washers.
- Overall length 4 3/8". Diameter 2 5/8" approx.
- Conforms to requirements of U.L. #558
- Mounting stem 3/4" diameter, 1/2" long, with two hex nuts and lock washer. (Note: Mounting nuts not to exceed 12 ft. lbs. torque).
- Designed for protection against battery drain, electrical fires, tampering and theft.
- Fits panels up to 1/4" thick.

51-927EP MASTER DISCONNECT SWITCH.

Continuous Rating (Make Break) = 180 AMPS @ 12VDC Intermittent Rating (Carrying Current Only) = 1800 AMPS @ 12VDC. 1 cycle = 4 seconds ON/20 Minutes OFF, Silver Plated 1/2" - 20UNF Copper Studs. Recommended wire size #00-gauge or larger for 1800 AMP application.

OUR NEW ENCAPSULATED "REMOVABLE KEY" VERSION OFFERS THE ULTIMATE IN SECURITY AND EASE OF OPERATION (Anti-Rotation Pin Version, also available)

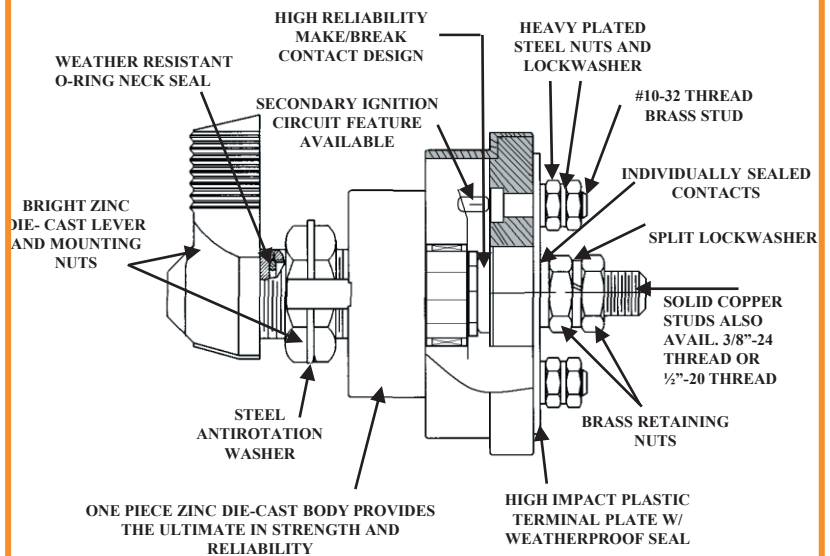

51-902EP

51-915 EP

Same as 51-902EP except with .25 anti-rotation indexing post.

51-916EP

Same as 51-915EP except with two encapsulated removable keys (31-332).



51-915EP



51-927EP



51-916EP

WIRING DIAGRAM FOR S.P.S.T. MASTER DISCONNECT SWITCH

Part Numbers: 51-302, 51-315, 51-316, 51-307

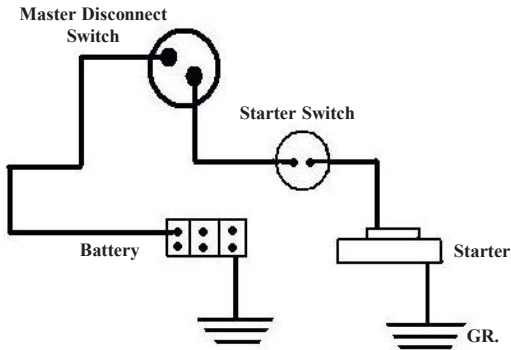

WIRING DIAGRAM FOR D.P.S.T. MASTER DISCONNECT SWITCHES. FOR USE WITH ALTERNATOR OR GENERATOR SYSTEMS

Part Numbers: 51-304, 51-318, 51-319

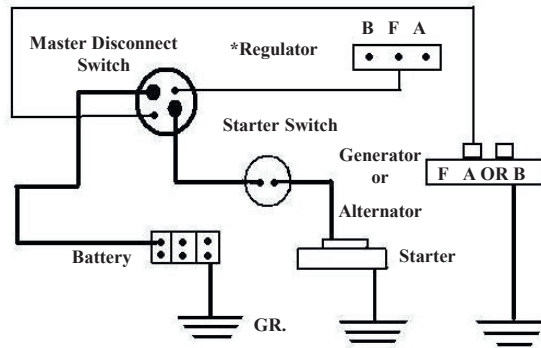

NOTE: Hex nuts against base Must remain stationary and Must not be tightened or loosened. Secure power cables to mounting surface no greater than 10" from switch mounting

ACCESSORIES

**51-904EP
LEVER OPERATED - 6-36 VOLT
D.P.S.T. (OFF-ON FOUR STUD TERMINALS)**
For battery and alternator or generator field circuit. Designed to break alternator generator circuit prior to battery circuit disconnect.



51-904EP

- Incorporated silver plated contacts.
- One piece die-cast housing sealed with O-rings at base and mounting stem to keep out dust and moisture.
- Two 3/8" and two #10-32 copper alloy stud terminals with hex nuts and lock washer.
- Overall length 4 1/8". Diameter 2 5/8" approx.
- Fits panels up to 1/4" thick.
(Note: Mounting nuts not to exceed 12 ft. lbs. torque).

RATING:

Continuous Rating (Make Break)
Large Studs – 180 Amps
Small Studs – 20 Amps
Intermittent Rating (Carrying)
Large Studs – 1000 Amps (20 sec. "On"
-5 Minutes "Off")

51-918EP

Same as 51-904EP except with .25" diameter anti-rotation indexing post.



51-918EP



51-919EP

51-919 EP

Same as 51-918EP except with two encapsulated keys (31-332).

51-303

FACE PLATE - For use with #'s 51-902, 51-905, 51-904, 51-907 Master Disconnect Switches. Polished aluminum with black letters. 2.5" diameter., .76 diameter center hole, .032 thick.



51-322

FACE PLATE - For use with #'s 51-915, 51-916, 51-917, 51-918, Master Disconnect Switches. Polished aluminum with black letters. 2.5" diameter, .76" diameter post, .032" thick.



51-308EP KIT

Replacement Zinc Die-Cast lever and Zinc Plated set crew for Pollak® Master Disconnect Switches.



51-311

Special flange plate and lever to accept a padlock for many lock-out/tag-out safety regulations.



31-332

Encapsulated Keys with Pollak® logo. Fits #'s 51-916EP & 51-919EP Disconnect Switches.



SWITCHES

ELECTRONIC DIMMER CONTROLS

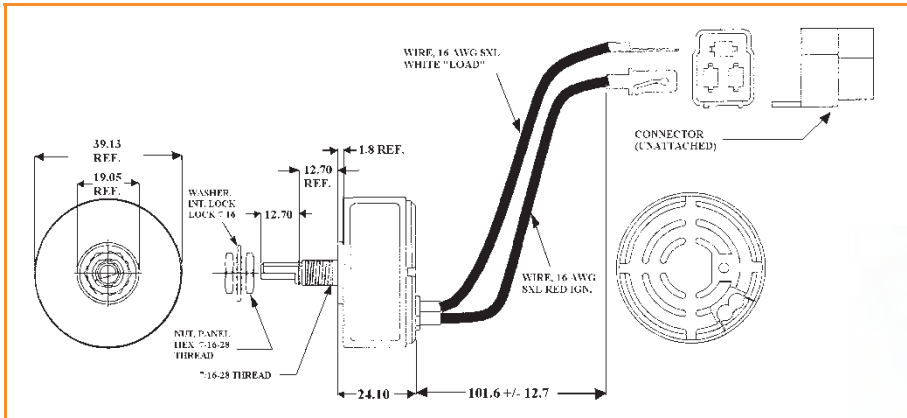

Part No.	Max Current Load	Connector Type	Panel Mount	Manufacturer Application
52-262	10 Amp	Packard Metri-pack #12034344	7/16"-28 Thread	Mack/Volvo/Gm*
52-263	10 Amp	Packard 56 Series	3/8"-32 Thread	Freightliner** Peterbilt** Kenworth**
* Note: Does not apply to all Volvo/GM models. Check with Manufacturer.				
** Installation sheet included for connecting terminals to connector.				

If you can't afford the down time to have your lights go out contact your nearest Pollak® distributor today.
NOTE: If Panel Lamp Dimmer is hooked up backward, the unit will not work. This will not damage the unit but it is important to insert terminals correctly

PRODUCT DESCRIPTION

The Electronic Panel Lamp Dimmer Control is a cost effective reliable method of safely controlling the intensity of dash board lighting in the cab of vehicles. Pollak® Panel Lamp Dimmer controls have been specified by Mack Trucks, Freightliner, Peterbilt and Kenworth. These manufacturers know that electronic reliability keeps trucks on the road and out of the shop. An electronic Panel Lamp Dimmer eliminates the old fashion rheostat type control. Sophisticated electronic pulse width control circuitry and power MOSFET technology used in the panel lamp dimmer's design eliminates the heat build up found with traditional rheostats. Pollak's two wire design allows the Pollak® controls to be a drop in replacement for existing rheo-stat applications, (see chart for appropriate part number). State of the art surface mount electronic design reduces the housing size and weight while eliminating expensive product failure caused by vehicle vibration. This Pollak® Panel Lamp Dimmer is designed in accordance with stringent SAE J1455 recommendations. Load dump and transient conditions will not adversely affect the dimmer's operation and it is completely protected from continuous short circuit overload. As dash panels become more complicated the strain on the panel dimmer is increased. The truck O.E.M.'s know this and have converted to electronic dimmers.

PRODUCT FEATURES

- Universal Application Design
- Simple Two Wire Design Replaces Old Three Wire Style
- Ground Connector Not Needed - Works on positive or negative vehicle systems
- Small Housing Easily fits most dashboards
- Light weight
- Smooth gradual dimming control
- Reliability of electronic components
 - Switch generates very low heat
 - Rugged vibration resistant design
- Operating temperature: -40C to + 85C
- Zinc die-cast housing
- Works ONLY on 12 VDC systems
- Wire strain relief
- Black plastic knob, white indicator arrow
- Power MOSFET Transistor design
- Meets SAE J1455
 - Fully short circuit protected
 - 150V load dump protected
 - 700V transient spike protected
 - Reverse Polarity protected
- Nominal 205° shaft rotation

SOLENOID SWITCHES

AUTOMOTIVE, TRUCK, FARM TRACTOR, INDUSTRIAL, CONSTRUCTION, OFF-THE-ROAD, RECREATIONAL VEHICLE APPLICATIONS

TYPICAL APPLICATIONS INCLUDE: SNOW PLOWS, TRUCK WINCH, LIFT TRUCKS, LOW VOLTAGE EQUIPMENT,

- 6-24 VDC Systems
- Plated Steel or Phenolic Housings
- Ignition & Ground Terminals, # 10-32 thread
- Contact Terminals 5/16"-24 Thread
- Bracket Mounting Holes; 5/16" x 19/32"
- 2 1/8" on Center

Contact Factory for availability of additional solenoids.

CONTINUOUS DUTY (6-24VDC), 150Amps In Rush "S.P.S.T."
Normally Open Contacts - Off - On

52-307-01 12V, 100 Amps, Continuous Duty, Insulated, with hardware. UL listed.



52-307-01

52-312-01 Same as 52-307-01 except grounded with three terminals (not shown, not UL listed).

52-315 Same as 52-307-01 except coated with protective grey plastic coating. (Dust & Moisture Resistant)

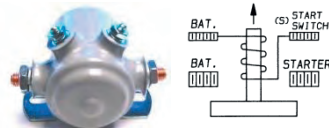

52-315

52-324-01 Same as 52-307-01 except 24 Volt, continuous duty. 100 Amps, (not shown, not UL listed)

52-337 - 12V, 100 Amp continuous duty with diode (see page 50 for more complete description).



52-337

52-327 12 Volt, continuous duty. 100 Amps

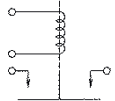

52-336 36 Volt, continuous duty. 100 Amps

52-329 12 Volt, continuous duty. 200 Amps

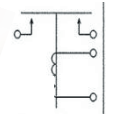

52-339 24 Volt, continuous duty. 200 Amps

Double Pole Single Throw

52-330 12 Volt, 2 circuits, SPDT, Normally Open /Normally Closed, continuous duty. 100 Amps, insulated

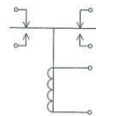

52-340 24 Volt version of 52-330

INTERMITTENT DUTY (6-12VDC, 750Amps Make, 100 Amps Break)
"S.P.S.T." Normally Open Contacts - Off - On

52-305-01 UNIVERSAL - 12-V Applications - Grounded Base, Flat Bracket, Internally grounded to housing, other end connected to small terminal.



52-305-01

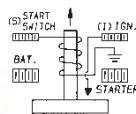

52-328 12V, 100 Amp, SPST, Insulated, Short Case

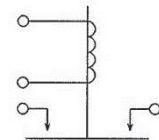

52-331 (Replaces 52-304). 12V, 600 Amp make, 200 Amp break, Normally off, SPST, one circuit Off/On, Short Case.



52-333 Heavy Duty, SAE J1171 Marine Rated, 10 Min. Duty Cycle

52-332 24V, 2 Min Cycle version of 52-331

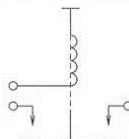

52-334 Heavy Duty same as 52-333 but not Marine Rated

DOOR SWITCHES

52-620 (SEALED) Door Jamb Switch for most Ford and Chrysler products, 14V at 10 Amps Lamp Load Overall length 2-1/8", Plunger travel 3/16", Self-tapping thread. Self-Adjusting.

52-622 Mating Connector for 52-620 Switch. Three 8" 18 gauge wire leads.

52-624 (KIT)
52-620 Switch and 52-622 Mating Connector.

52-616
UNIVERSAL, 5 Amps @ 12V, Screw Terminals "ON" when plunger is out. Dual Mounting Hole 1-3/8", 2-1/16" on center. REPLACES: Chrysler 882943, KF-204229,

52-623
Door Jamb Switch to accept two Bullet Terminals. Weather Resistant plastic plunger and body. Accepts two bullet terminals. Fits panels .030" - .070" thick. Mounting hole .850 diameter. max., 5 Amps @ 12V. REPLACES: Ford OA1-13713, BOA-13713, B9MT-13713A, C3AZ-13713A.

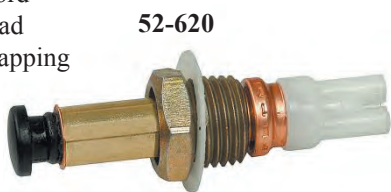

52-620



52-622

52-633
52-620 with mounting hardware.

52-625 – Shell for 52-622

52-626 – Boot for 52-622

52-627 – Pin for 52-622



52-616



52-623

AXLE SWITCH



52-260
TWO SPEED AXLE SHIFT LIMIT SWITCH. For use in controlling the Eaton two speed electric axle. Phenolic insulator base with O-Rings on studs. Used with Pollak® #52-261 Axle Switch.

AXLE SWITCH



52-261
2 Position Both On controls. High and Low Axle Ranges. Die-cast body protected with rubber cover. Three Female Terminals to receive Bullet Terminals. For use in controlling the Eaton two speed electrical axle.

STOPLIGHT SWITCH

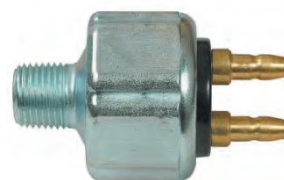

52-104 (N.O.)
HYDRAULIC (60-100 P.S.I.) Pressure switch

DIMMER SWITCHES

2 POSITIONS - ON (Low Beam) ON (High Beam) S.P.D.T.



52-250
UNIVERSAL - Mounts through floorboard. Three 1/4" - 20 tapped holes, 3/4" and 1-3/4" on center, With 3 Flat Screw Terminals and 4 Bullet Terminals supplied in separate hardware kit. 3 Screw Terminals.



52-252
Floor Mounted Type. Mounting holes 1-5/8" on center, 7/32" diameter., 3 Special Terminals, for Plug connection.



52-253
Special Floor Mounted Type. Mounting holes 1-6/8" on center, 9/32" diameter., 3 Special Terminals for Plug Connection.

CIRCUIT BREAKERS

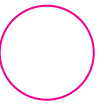
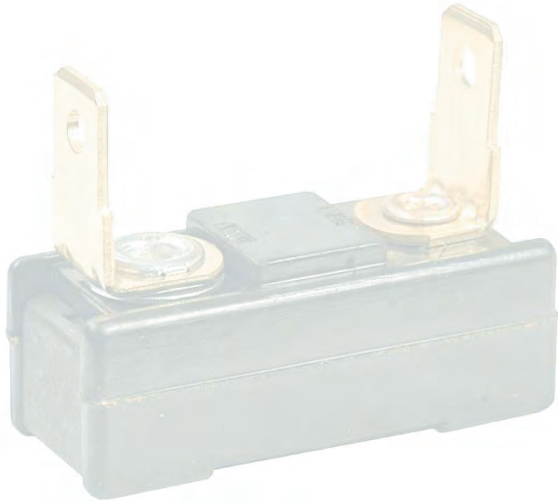

CIRCUIT BREAKERS

What are Circuit Protection Devices and how do they work?

Circuit Protection Devices are manufactured for use in multiple power strips, boats, recreational vehicles, battery charges, welding equipment, portable generators, agricultural equipment, trucks, passenger and school buses and off-road construction equipment.

GENERAL OPERATING PRINCIPLES

Circuit Protectors are single pole thermal type devices. Basic construction consists of two terminals, one terminal with a composite alloy reed to which a precious metal contact has been attached, and the second terminal with a precious metal contact. When a circuit protector is assembled and in the operational mode, the precious metal contacts rest against each other. Current flow is from one terminal through the composite alloy reed to the contacts and out the second terminal. In general, the size, material composition and the way the reed is processed during manufacturing, coupled with the type of contacts and terminals, determines the current rating of the device. Under normal conditions, circuit protectors are designed to handle 100% of rated current on a continuous basis. When the current rating is exceeded heat will be generated and the composite alloy reed will bend up, separating the contacts. The speed at which this process occurs is dependent on two main variables, the amount of current in excess of rating and temperature. The method in which the breaker is reset depends on the types of breakers used.

Automatic Reset

Type 1 will cycle continuously during an over-current condition. The composite alloy material will bend and separate the contacts when an over current situation occurs and return to the run mode as it cools. This process will continue until the source of the over-current is removed or corrected.

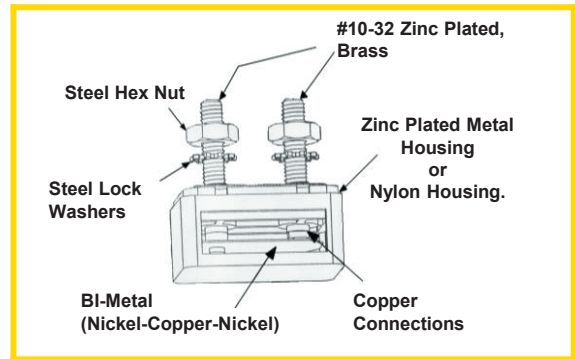

Modified Reset

Type 2 Unlike the auto reset design, Type 2 has an additional resistive component built into it which raises the ambient temperature within the circuit protector. This limits the number of cycles (less than 10) by not allowing the composite alloy to cool and reset the circuit. The circuit will remain open with less than 1.0 amp current flow as long as the voltage is applied.

Manual Reset

Type 3 circuit protector introduces a non-current carrying object between the contacts when they open. To reset the contacts, an external button or lever must be activated to return to normal operation.

Sizing A Circuit Protector

Temperature and percent of rated current will affect the performance characteristics of a thermal circuit breaker. These parameters should be taken into consideration when specifying which size and type device is needed for your application. All Pollak® circuit protectors are designed to run continuously at 100% of rated current at 77°F. However, as a general rule you should size your breaker so that your continuous current is 75-80% of the rated current of your circuit protector. For example, if your application runs at a continuous 8 amps, you should choose a 10 amp breaker.

Another major factor to consider is the affect that temperature has on the rating of the circuit protector. As with all thermal devices, as temperatures change the continuous current rating of the circuit protector changes. As stated earlier, all Pollak circuit protectors are designed to run continuously at 100% or rated current at 77°F. The bottom chart shows the effect temperature has on the rated current for circuit protectors.

Notes: Circuit Breakers vs fuses		
	Circuit Breaker	Fuse
Resettable Cycles	Yes	No
Adjustable Ambient Compensation	Yes	No
Locate Anywhere (even under hood)	Yes	No
Permanent Mounting Capability	Yes	No

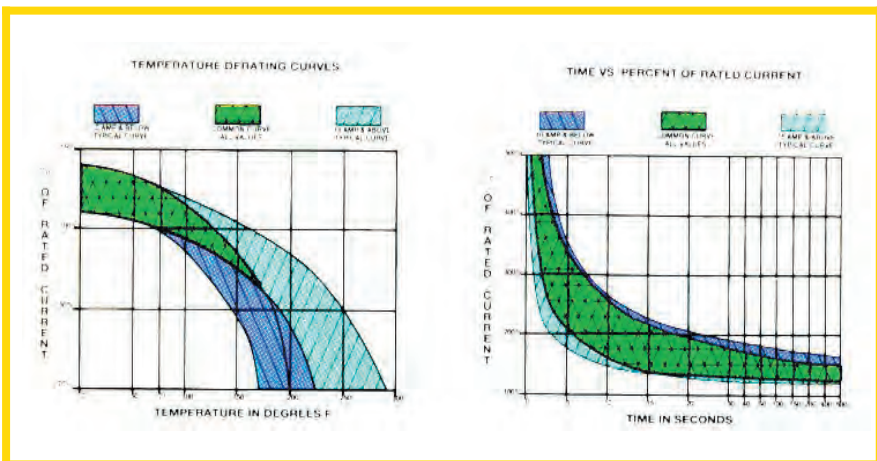

Typical Circuit Breaker Applications

Accessory Circuit, Cooling Fan, Door Locks, Headlamps, Tail Lamps, Window Lift, Sunroof, Trailing Package

CIRCUIT BREAKERS - TYPE I Cycling - Automatic Reset

Single Pole Thermal Type Breakers

Rating From: 5A to 50A; 12VDC.

Operating Temperature: -10°F (-23°C) to 150°F (65°C).

Storage Temperature: -20°F (-29°C) to 200°F (93°C).

Applications: Battery charges, trucks, buses, RV's, trolling motors, etc..

NOTES: PLASTIC VS METAL

- **VIBRATION**...Plastic housings with mounting brackets are one piece molded and are less prone to vibration. Metal housings with brackets are two piece designs. The bracket is attached by spot welding and can be loosened by vibration.
- **SHORTING OUT**...If a wire should loosen from a terminal on a plastic housing version, it will not short out against the housing as it may do with a metal housing.
- **WEIGHT**...The plastic housing is also lighter than the metal housing.

NOTES: 24V VS 12V CIRCUIT BREAKERS

- A 24V Circuit Breaker may be used in a 12V application because of the thermal metals used in assembly. However a 12V Circuit Breaker is not recommended for 24V since the materials are Heat affected...not current affected.

Ampere Rating	Plastic Base 12 VDC	Metal Base 12 VDC
10	54-110PL	*
15	54-115PL	54-115
20	54-120PL	54-120
25	54-125PL	54-125
30	54-130PL	54-130
35	54-135PL	*
40	*	54-140
50	54-150PL	54-150

* Currently not available No Mounting Bracket

Ampere Rating	Plastic Base 12 VDC	Metal Base 12 VDC
15	54-215PL	54-215
20	54-220PL	54-220
25	*	54-225
30	54-230PL	54-230
30	54-831PL (Plastic 24 VDC)	
40	54-240PL	54-240
50	54-250PL	54-250

* Currently not available 90° Mounting Bracket

Ampere Rating	Plastic Base 12 VDC	Metal Base 12 VDC
10	54-510PL	*
15	54-515PL	54-515
20	54-520PL	54-520
25	*	54-525
30	54-530PL	54-530
40	54-540PL	54-540
50	54-550PL	54-550

* Currently not available Straight Mounting Bracket

Terminal Options – Battery Terminal has yellow dichromate plating
Aux Terminal = Zinc Plating

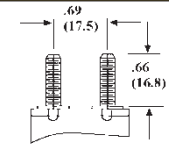

TWO 10-32 STUDS;
.66 (AUX & BAT)

METAL COVER

PLASTIC COVER

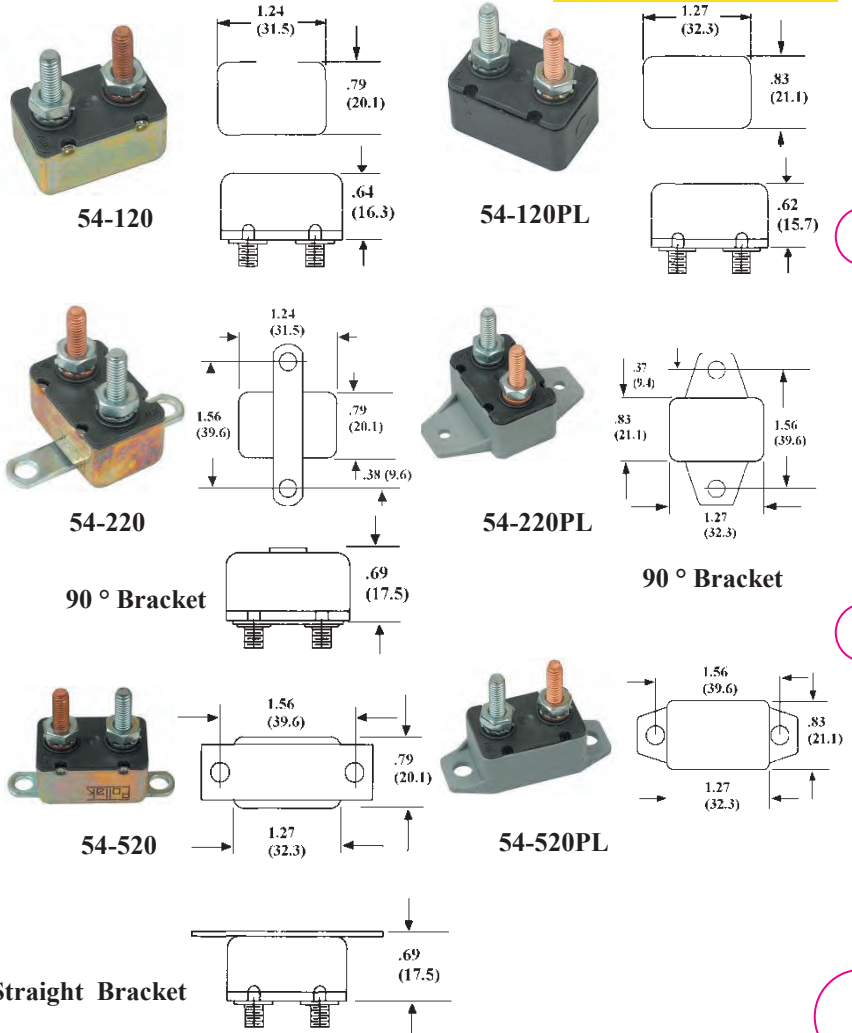

Circuit Breakers - Type II

Plug-In Terminal Type

Non-Cycling - Modified Reset

Designed with an additional resistive component this style breaker remains open as long as power is available or until the load is removed.

Special "snap-off" feature provides three lengths of .300, .500, or .750" (18 mm) H. Blades = .78" (19.9 . Body = 1" (25.27 mm) L x .40" (10.03 mm) W x (.70mm) L

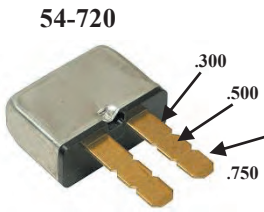

Blade Type Part #	Ampere Rating
54-705	5
54-710	10
54-715	15
54-720	20
54-725	25
54-730	30

NOTES: STUD TERMINALS VS .250QC BLADE TERMINALS

- **ACCESSIBILITY/VIBRATION** . . . If the circuit breaker is not easily accessible or subject to vibration then stud terminals/lock washers are preferred.
- **OFF-ROAD, CONSTRUCTION** . . . For Quick Connect applications (i.e.. Bus, RV, Conversions...) 250 quick connect terminals are preferred.

Sealed Circuit Breakers (Type I)

- Designed for exposed applications (moisture, dust, oil).
- With and without mounting brackets.
- Supplied with 12" wire loop.

Ampere Rating	Sealed	Sealed with Bracket
20	54-920	54-921
30	54-930	54-931
40	54-940	54-941



MOUNTING BRACKETS

Rugged steel brackets with detents permit simple snap-in of 54-115 thru 54-150 (Type 1) series metal only circuit breakers.



52-241

No. Gangs	Part No.	Length	Mounting Hole Center
2	52-240	4.81"	4.00"
4	52-241	6.63"	5.81"
6	52-242	8.44"	8.44"
8	52-243	10.25"	10.25"

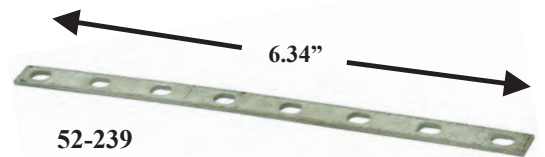

52-239

Bus bar for studded circuit breakers.
.20 X .30 slots (.91 typ. On center)



52-249

7-Breaker Junction box

L 7..5" X W 3.75" X H 2..5"

CIRCUIT BREAKERS - TYPE II

Maxi-Style Plug-In

OEM style replacement circuit breaker for Ford, Paccar, & Freightliner Body= (29.9mm) L x (8.90mm) W x (21.6mm) H Blades= (12.7mm) L

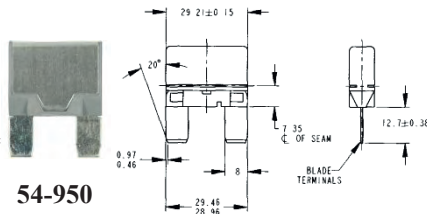

ATO Style Plug-In

OEM style replacement circuit breaker for Ford Class 8 Vehicles Body= (29.9mm) L x (8.90mm) W x (21.6mm) H Blades= (12.7mm) L

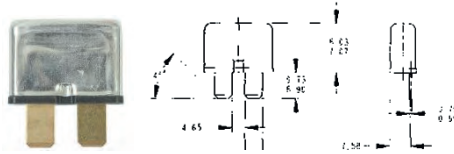

Mini-Style Plug-In

OEM style replacement circuit breaker for Freightliner and Paccar Class 8 Vehicles Body= .98" (24.90mm) L x .40" (9.50mm) W x .70 (18.0mm) H Blades- .50" (11.00mm) L x 11" (2.90mm) W

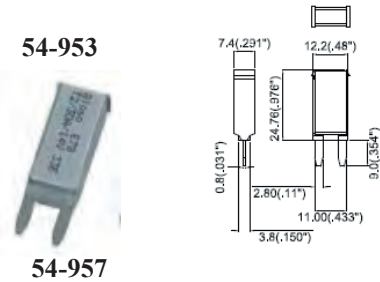

MAXI STYLE METAL: TYPE II-Non-Cycling-Blade Terminals

Ampere Rating	Blade Terminals	Style
20	54-950	Generic
30	54-951	Generic

ATO STYLE METAL: TYPE II-Non-Cycling-Blade Terminals

Ampere Rating	Blade Terminals	Style
10	54-953	Ford HD 8
15	54-954	Ford HD 8
20	54-955	Ford HD 8
30	54-956	Ford HD 8

MINI BLADE METAL: TYPE II - Non-Cycling-Blade Terminals

Ampere Rating	Blade Terminals	Style
10	54-597	Freightliner HD 8
15	54-958	Freightliner HD 8
20	54-959	Paccar HD 8
30	54-960	Paccar HD 8

CIRCUIT BREAKERS - TYPE III

Push Button - Manual Reset

Breaker remains open on overload and has to be manually reset with the push of the button.

Single Pole Thermal Type Breakers

Rating From: 5A to 50A; 12VDC – 24VDC

Operating Temperature: -10°F (-23°C) to 150°F (65°C).

Storage Temperature: -20CF (-29°C) to 200°F (93°C).

Applications: Battery charges, trucks, buses, RV's, trolling motors, etc.

Ampere Rating	Plastic	Plastic w/ 90° Bracket	Maxi-Style
10	*	*	54-311PL
15	*	54-616PL	*
20	*	*	54-321PL
25	*	*	*
30	54-630PL	54-631PL	54-331PL
40	54-640PL	54-641PL	*
50	54-650PL	54-651PL	*

Note: Maxi-Style Breakers plug into Pollak Blade Type Fuse Panels. (See page 48)

54-630PL

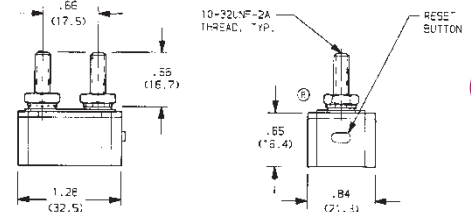

54-631PL

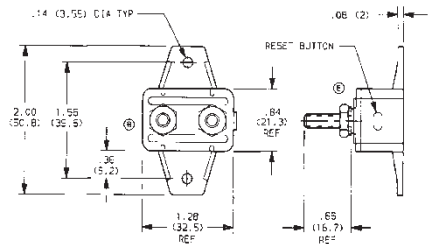

54-311PL

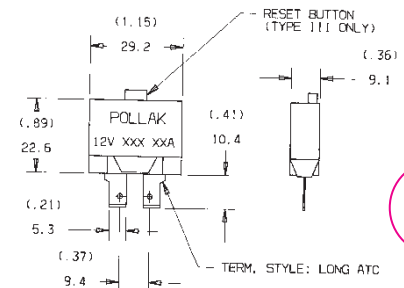

CIRCUIT BREAKERS - HIGH AMP

Manual trip push button on Series 54-870PL. Open circuit indication via reset lever position.

Type I & III Single Rate Thermal Type Breakers

Rating: from 40A to 150A; 12VDC.

Operating Temperature: -25°F(-32°C) to 180°F(82°C).

Storage Temperature: -30°F(-34°C) to 300°F(149°C).

Applications: Typically used in auxiliary and accessory circuits - trucks, buses, RV's and marine applications. Others might include battery charges and DC audio systems. Sealed for engine compartment and bilge area applications.

Housing: Thermoset plastic:

Mounting: Panel or surface.

Indicator: Series 54-870 (Type III) have a unique reset mechanism which provides visible indication of tripped condition. Splash Proof, Dust Proof.

Operating Temperature: -25°F(-32°C) to 180°F(82°C).

Storage Temperature: 15° to 250° F, (Available in other amperages upon request - 50 to 150 Amps).

Ampere Rating	Type I Auto Reset Surface Mount	Type I Auto Reset Panel Mount
60	54-850PL	54-860PL
80	54-853PL	54-863PL
100	54-851PL	54-861PL
120	54-854PL	54-864PL
150	54-852PL	54-862PL
200	54-855PL	*
250	54-856PL	*

Ampere Rating	Type III Switchable Manual Reset Surface Mount	Type III Switchable Manual Reset Panel Mount
60	54-870PL	54-880PL
100	54-871PL	54-881PL
150	54-872PL	54-882PL
80	54-873PL	54-883PL
120	54-874PL	54-884PL

Ampere Rating	Manual Reset Only Surface Mount	
200	54-875PL	*
250	54-876PL	*



Type I Auto Reset



Type III Switchable



Manual Reset Only

SURFACE MOUNT

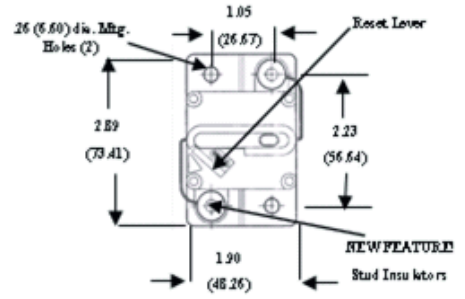

TYPE III MOLDED COVER

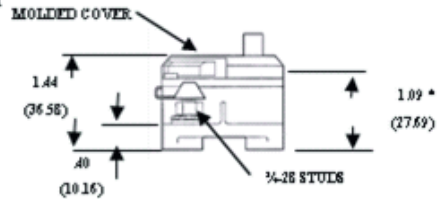

PANEL MOUNT

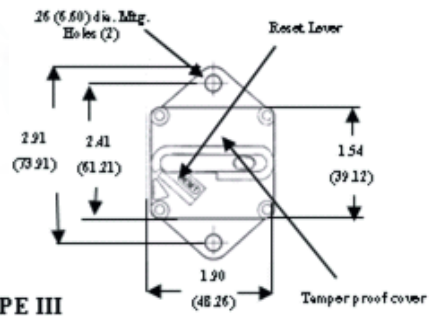

TYPE III MOLDED COVER

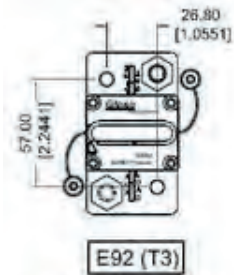
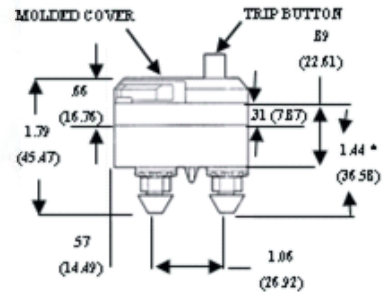

3/8" stud size max 250Amp wide (longer) surface new model

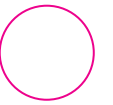

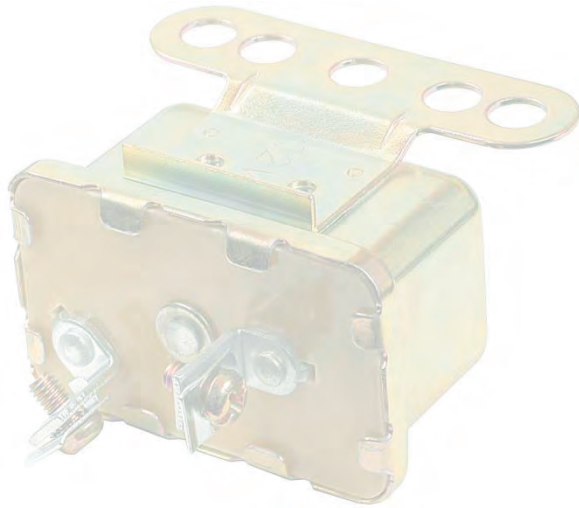

SPECIALIZED ELECTRICAL PRODUCTS

SPECIFICATIONS

Interchangeable Blade Terminals:

Accepts ATC® blade-type fuses, or blade-type, auto or manual reset circuit breakers.

Wiring: Output terminals - .250" x .032" OC rated 30A max. per circuit; Input terminals - #10-32 stud input rated 150A max.

Positions: Provides 6-24 protected output circuits.

Material: Black, thermoplastic, -20°F to 150°F.

Applications: Compact and lightweight, yet rugged enough for use in trucks, buses, boats, RV's etc.

Other Features: No top cover needed; recessed trifurcated fuse contacts.

Recessed mounting holes.



52-406

ATC BLADE TYPE FUSE PANEL

Position	Blade Type	Dimensions	Mounting Hole Center
6	52-406	L 2.47" x D 3.38" x H 0.81"	0.62"
8	52-408	L 3.09" x D 3.38" x H 0.81"	1.25"
10	52-410	L 3.72" x D 3.38" x H 0.81"	1.87"
12	52-412	L 4.34" x D 3.38" x H 0.81"	2.50"

FUSE PANEL

Position	Blade Type	Blade Terminals	Dimensions
12	52-214	52-214Q	L 7.38" x D 2.0" x H 0.56"

For economical tight cluster mounting of 1/4" x 1-1/8" fuses. Breakaway design, 300 volt rating. Blocks are molded glass-filled thermoplastic, polyester clips are spring-bronze; Alboloy-plated.

Junction Boxes



52-248
10-Terminal
Junction Box



52-249
7-Circuit Breaker
Junction Box



52-259
7-Terminal
Junction Box

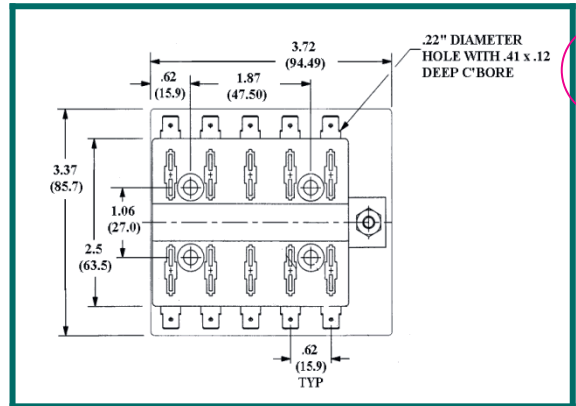

TERMINAL BLOCKS (Non Feed-Thru)

Rating: 30A, 12 VDC.

Operating Temperature: 250°F (120°C).

Standards: 2 to 10 steel studs on .750" centers and a "dog point" to guide nut into 10-24 thread.

Torque: Recommended 20 in / lb (25 in / lb max).



52-244

No. of Gangs	Terminal Block	Length	Mounting Hole Center
4	52-244	4.5"	0.62"
6	52-245	6"	1.25"
8	52-246	7.5"	1.87"
10	52-247	9"	2.50"

TERMINAL BLOCKS WITH INDEPENDENT FEEDS

No. of Gangs	Terminal Block	Dimensions	Mounting Hole Center
4	52-270	L 2.51" X W 1.37" X H 0.75"	2.18"
6	52-271	L 3.38" X W 1.37" X H 0.75"	3.06"
8	52-272	L 4.25" X W 1.37" X H 0.75"	3.93"
10	52-273	L 5.13" X W 1.37" X H 0.75"	4.81"
14	52-274	L 6.87" X W 1.37" X H 0.75"	6.56"

Rating: 20A, 12 VDC

Center Spacing: 7/16"

Wiring: Terminals will accept maximum wire size of AWG #12.

Terminal Screw Size: #6-32 phillot combination.

Distance Between Barriers: 0.353".

Mounting: #6 Screws.

Temp. Rating: °F(°C); 302 (150) max. -40 (-40)min.

BATTERY JUMPER TERMINALS

- Jumper terminals designed to provide remote mounting for battery connections either inside or outside of the vehicle.
- Easily installed, the positive terminal can be individually used or in conjunction with the negative terminal as a pair.
- Rubber caps, solid brass studs, brass hex nuts and brass lockwashers.
- Dimension for grooved contact post: 13/16" (20.63mm) dia., 1-1/8" (28.77) long.



52-138
Red Cap - Positive Terminal



52-139
Black Cap - Negative Terminal

SEALED BEAM FLASHER CONNECTORS

52-255
2 Wire connector assembly used on all vehicles with 2 prong seal beam lighting, or 2 prong flashers



52-255

52-256
3 Wire connector assembly used on 3 prong seal beam lighting, or 3 prong flashers.



52-256

PILOT LIGHT

52-115
12 VOLT PILOT LIGHT. Red 1/2" diameter faceted lens. For panel mounting through 5/16" hole. Has snap-out socket for conventional bulb replacement.



52-115

BUZZER

UNIVERSAL
Truck Low Air Pressure And Bus Rear Door Warning

52-400
12 Volt-2 Screw Terminals. 76dB @ 4: REPLACES: Ford FDM 2938A; GMC Truck and Coach 76023; Wayne Works Div., Divco-Wayne E-11811A and other 12 volt applications.

52-400



HORN BUTTONS

52-660
Large IVORY Button, 1-11/16" Dia. with clamp-On Bracket. Fits Steering column up to 1-1/2".

52-660



52-777
Large BLACK Button , Chrome Plated Housing.

52-777



52-661
FLAT SURFACE MOUNTING BLACK Plastic Button, Nickel Plated Housing, Mounting Holes 2-1/8" on centers

52-661



STOP LIGHT SWITCH

52-602
MECHANICAL. REPLACES DR-1997901, 1997915 & 1997922



Look What's *NEW*...

Pollak[®]
by **SMP**[®]

Home About Pollak Contact Us Request Information

OUR PRODUCTS For the Heavy Truck, Off-Road, RV and Towing Industries

Search Catalog: By Keyword

Pollak by SMP is a Leading Supplier of Electrical Connectors, Switches, and Sensors

Electronic-Logging-Device Back Up Alarms Precision Ball Switches Circuit Breakers Connectors

Door Lock Actuators Fuel Selector Valves Starter Switches Battery Master Disconnect Switches Merchandising Displays

Miscellaneous Switches Momentary Switches Push-Pull Switches Rocker/Toggle Switches Specialized Electrical Products

Since 1909 Pollak by SMP has developed, manufactured, and supplied a wide variety of electro-mechanical products including Connectors, Adapters, Toggle Switches, Rocker Switches, Door Switches, Door Lock Actuators, Pedal Switches, Ignition Switches, Fuel Selector Valves, Back-Up Alarms, Circuit Breakers, and related items for the Heavy Truck, Off-Road, RV, and Towing Industries..

Pollak® by SMP® 3718 Northern Blvd., Long Island City, NY 11101

Pollak[®] has a “new and improved” website; visit us at www.pollakaftermarket.com

Pollak[®] NEW 12 Volt Solenoid, Includes Diode

52-337



When power is applied to the relay coil, a magnetic field is created and energy is stored in the coil. When power is removed, the magnetic field collapses causing a reverse voltage to be generated (it's called inductive kickback or back EMF). The back EMF can easily reach 200 volts. The diode will absorb the reverse voltage spike. This voltage, if not absorbed by the diode, will cause premature failure of switch contacts or feed back to other crucial vehicle electrical parts.

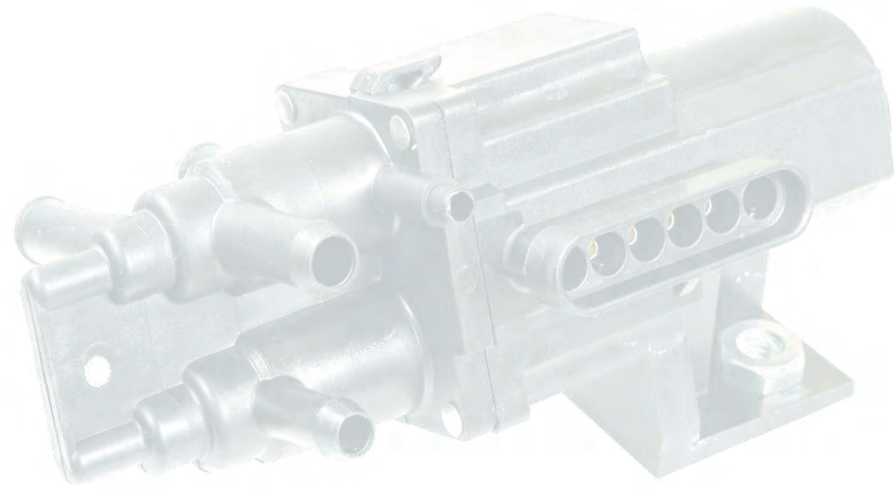

VALVES

FUEL TANK SELECTOR VALVES

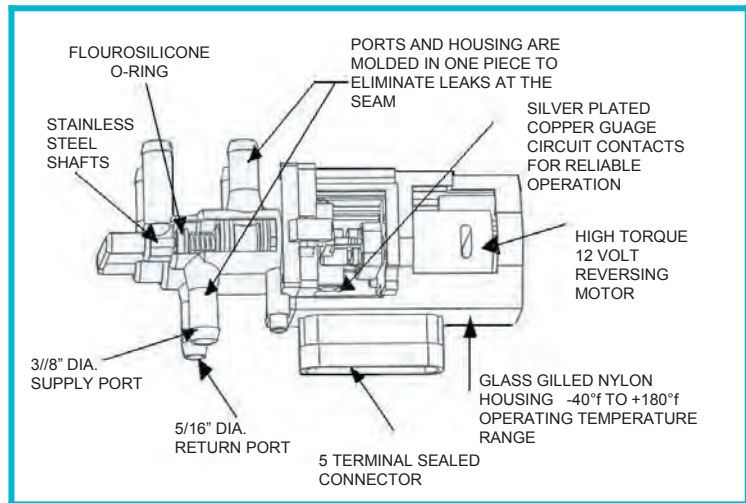
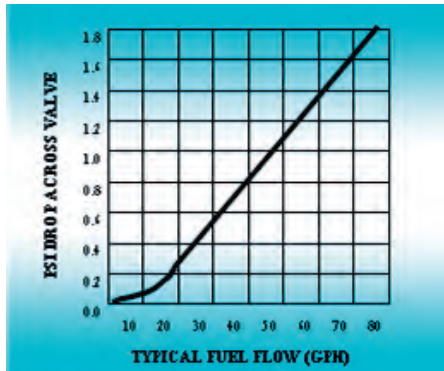

MOTORIZED FUEL SELECTOR VALVES -

(Diesel or Gas) These valves are designed for use in applications which involve in-tank fuel pumps, not exceeding the rated pressure of the valve. Motorized valves are driven into position by an electric motor and are stable in either position. They only draw power for a fraction of a second during transfer. A switch in the valve shuts off the motor when the valve reaches the selected position.

NOTE: Another switch within the valve provides automatic fuel gauge readout for selected tank.

42-159 (65 PSI) LIGHT TRUCK 6-PORT MOTOR DRIVEN VALVE

Incorporates six ports including return, draws -.5 amps. max. at 12 volts, fits 3/8" I.D. hose for fuel supply and 5/16" hose for return lines. Mounting holes: 2 5/16" threaded nuts on 1 3/16" centers. Valve remains in actuated position after power is disconnected. For new installations 42-203 connector and 34-592 toggle switch required. Installation sheet included.

42-300 KIT - 6 PORT MOTORIZED VALVE; CONNECTOR, SWITCH AND FACE PLATE

Contains: 42-159, 42-203, 34-592, 42-201
Specifications: Same as 42-159

42-302P KIT - 6 PORT MOTORIZED VALVE AND CONNECTOR

Contains: 42-159, 42-203
Specifications: Same as 42-159



FUEL TANK SELECTOR VALVES

42-151

3 PORT MOTORIZED VALVE

Maximum Fuel System Pressure: 65
psi Fuel Hose: 3/8" ID. Connector
(Required): 42-203 Recommended
Fuse: 7.5A

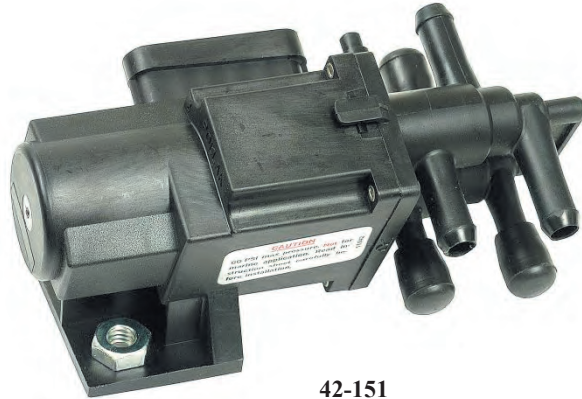

42-151

42-308

KIT-3 PORT MOTORIZED VALVE; CONNECTOR, SWITCH AND FACE PLATE

Contains: 42-151, 42-203, 34-592, 42-201
Specifications: Same as 42-151

SERVICE TIPS

Motorized Valves – Use 18 AWG (or heavier wire for long runs) to insure adequate voltage at the valve during operation. These valves are designed for use in vehicles with 12 volt systems.

Motorized Valve Common Solutions for the 42-159 & 42-151

PROBLEM- *The gauge reads the fuel level in the wrong tank.* Check the wiring for the fuel tank gauge sending units to the valve. Exchanging the wires to terminals “A” and “C” may correct this.

PROBLEM- *The valve won't switch tanks.* Check all wiring to the valve. The valve changes position when the voltage polarity at the terminals “D” and “E” is reversed. The valve should always have 12 volts between terminals “D” and “E”.



42-201



34-592

General

Always use fuel filters between the tanks and the valve. Contamination from unfiltered fuel is a leading cause of valve damage and resultant failure.

These valves are not for marine applications.

Not for use with water. These valves are designed and manufactured to provide trouble free operation in multiple tank fuel systems. The internal components require diesel or gas fuel to lubricate the working parts.

Do not allow valves to remain dry for extended periods of time. Dried fuel will cause the internal seals to stick and can damage them when the valve is eventually actuated. The use of a fuel stabilizer during long term storage is recommended.

FUEL TANK SELECTOR VALVE ACCESSORIES



**34-592
Toggle Switch
D.P.D.T.**

Circuit: DPDT ON-ON Reversing
Positions: 2
Termination: 6 Screw 2 Jumper Blades
Mounting: 15/32" Dia. Bushing



Rocker Switch 34-359

Reversing Rocker Switch,
(Main/Aux.)
On-On D.P.D.T. 2 Positions,
6 Blade Terminals with
Jumper Blades, Fits .830" x
1.450" Panel Cutout in .093,
.125, .187 thick panels.
Black Bezel & Actuator.
Housing has nylon gasket for
protection against moisture
intrusion.



**Motorized
Valve Connector
42-203**

Connector,
Type: 5 Wire, Weatherproof
Pigtail: 5" 18 Gauge Wires



42-201

Faceplate (Supplied in 42-300)
Material: Bright Nickel Plated
Steel Legends: AUX, MAIN



**25-371
1/2 Toggle Boot**

Same as Toggle Boot #25-370
except allows Toggle Handle
(of any length) to protrude.
Accommodates all toggle lever
diameters from .155" - .240"
including all Pollak toggles
except nylon handle series.



**25-370
Toggle Boot**

EPDM Rubber Boot with 15/32-32
thread. Provides protection against
salt spray and is resistant to weather
and ozone. Can be used on 34-570
Series and other toggle switches with
15/32" Dia. mounting stem.

ALARMS

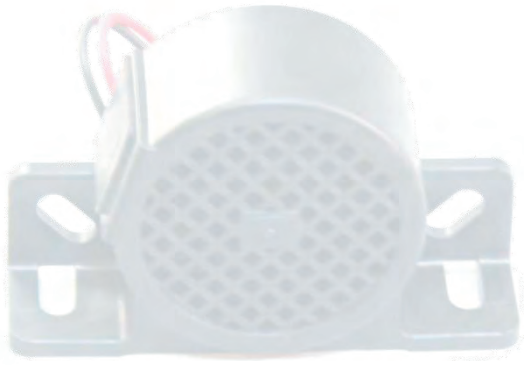

BACK-UP ALARMS

Pollak® provides a complete family of back-up alarms manually adjustable and single level. Selection of a back-up alarm should result in an alarm that has a sound level output higher than the ambient noise level of the work environment.

Features Standard To Pollak® Electronic Back-Up Alarms:

- Manufactured of high-impact, non-corroding nylon.
- 100% Factory Tested
- Solid state electronics sealed against dust, moisture, and vibration.
- Can be used in positive or negative ground vehicles.
- Steam cleanable.

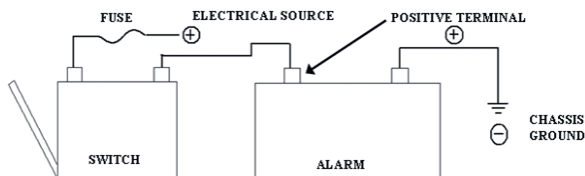

41-761 (9-24 Volts)

MANUALLY ADJUSTABLE 112/107/97db

Heavy-duty adjustable unit for largest construction and mining vehicles, graders, dumps, crawlers, tractors, belly dumps, etc. Designed for high performance, the most compact lowest cost unit of this type available.

SPECIFICATIONS:

- Adjustable sound levels... 112dB... 107dB...97dB(A) ±4 @ 4'
- Multi-voltage 9 to 24 volts
- Voltage spike protected
- Current draw less than 1 amp
- Solid state electronics
- Certified conformance to S.A.E, J994, types A, B, & C
- Meets State, Federal, O.S.H.A., Bureau of Mines, and Army Corps of Engineers' requirements
- Size - 5" W x 4.7" D x 3.1" H
- Mounting - 2" x 4 -1/4" centers
- Net weight - 2.0 lbs.

FEATURES:

- Made of high impact, non-corroding plastic
- Weather resistant and steam cleanable
- Operates in temperature ranges (-40° F to +170° F)
- Can be used on positive and negative ground vehicles

41-761

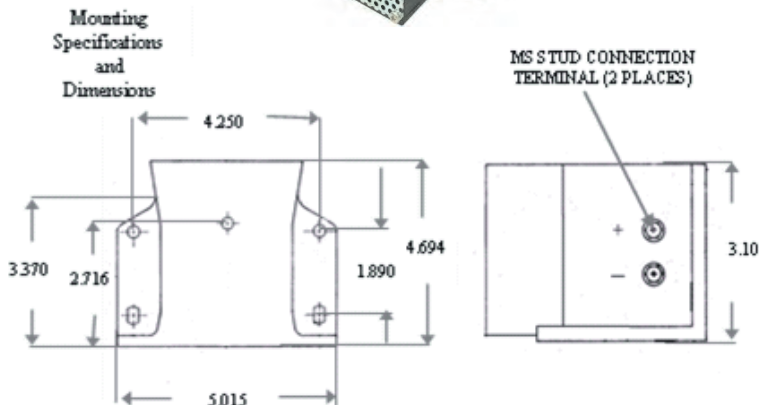

41-802

- Robust Heavy Duty Switch
- Water Resistant
- 15 Amps @ 12VDC
- Single Pole Double Throw with 360 Degree Movement
- Mounting Bracket & Instruction Sheet Included



41-706

- Switch for vehicles not equipped with automatic back-up light circuit. Mounts adjacent to reverse shift
- Spring loaded lever permits over-travel
- Normally off
- 2.5 Amps Inductive @ 14-28V



For vehicles not equipped with an automatic back-up circuit. Use with any back-up alarm, but the "Pro's" trust Pollak®.

BACK-UP ALARMS

Pollak® provides a complete family of back-up alarms manually adjustable and single level. Selection of a back-up alarm should result in an alarm that has a sound level output higher than the ambient noise level of the work environment.

NEW: 41-851, 41-820, 41-821& 41-822

- **Slotted mounting – ‘drop in’ replacement**
- **Wire leads enhance corrosion protection** (from traditional studs)
- **New design – smaller size, less heat, longer life**
- **Consult factory for additional models**

41-851 (12-24 Volts) SINGLE LEVEL 107db

A Medium to Heavy-Duty unit for off-highway trucks, dump trucks, loaders, cranes, backhoes, etc.

SPECIFICATIONS:

- Single level...107dB (A) ± 4 @ 4'
- Voltage spike protected
- Reverse polarity protected
- Current draw less than 0.3 amps
- Solid state electronics
- Certified conformance to S.A.E. J994, type B
- Meets all European Standards for on and off-road vehicles (CE & E-Mark Certified)
- State, Federal, O.S.H.A., Bureau of Mines and U.S. Army Corps of Engineers' requirements
- 12" Wire Leads
- Size-5"Wx3.25"Dx3."H
- Mounting – 2 slots .75"Lx.25"W and 2 slots 1"L x .25"W on 4.25" centers
- Net Weight - 1.2 lbs.

FEATURES:

- Rugged Glass-Filled Nylon Housing
- Steam cleanable/Pressure Washable
- Low Current High Efficiency Dome Speaker
- Meets extreme requirements of off-highway equipment
- Operates in temperature ranges (-40° F to +185° F)
- Can be used on positive and negative ground vehicles

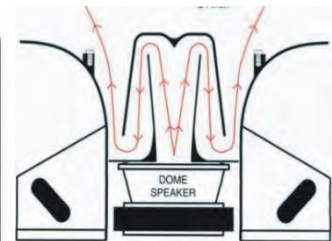

Patent Pending *Dome Speaker* demonstrating the self-cleaning feature; expelling concrete dust.

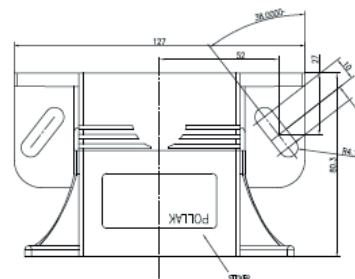
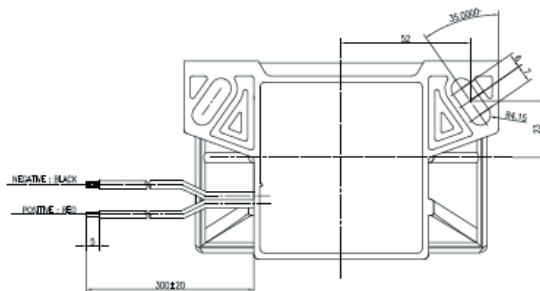

**41-820 (12-24 Volts)
SINGLE LEVEL 97db**

The rugged and compact 41-820 allows replacement of unnecessarily large and bulky alarms currently used on light and medium duty trucks, dump trucks, motor homes, campers, electric fork lifts and other similar applications.

SPECIFICATIONS:

- Single level...97dB(A) ± 4 @ 4'
- Multi-voltage -12-24 volts
- Voltage spike protected
- Reverse polarity protected
- Current draw less than 0.3 amps
- Solid state electronics
- Certified conformance to S.A.E. J994, type C
- Meets State, Federal and U.S. Army Corps of Engineers' requirements
- Meets all European Standards for on and off-road vehicles (CE & E-Mark Certified)
- Size-4"Wx1.25"Dx2.5"H
- Mounting – four .5"Lx .25"W slots on 3.25" centers

FEATURES:

- Rugged glass-filled nylon housing
- Steam Cleanable/Pressure Washable
- Can be used on positive and negative ground vehicles
- Compact size allows for horizontal or vertical mounting in protected areas

**41-821 (Not Shown)
Same as 41-820 but with Stud Terminals**

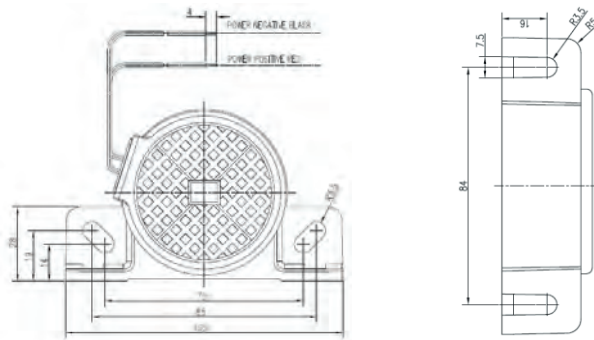

**41-822 (12 to 24 Volts)
SINGLE LEVEL ALARM 107db**

For use in medium to light duty applications where a louder warning level is required.

SPECIFICATIONS:

- Single level...107dB(A) ± 4 @ 4'
- Multi-voltage-12-24 volts
- Voltage spike protected
- Reverse polarity protected
- Current draw less than 0.3 amps
- Solid state electronics
- Certified conformance to S.A.E. J994, type B
- Meets State, Federal and U.S. Army Corps of Engineers' requirements
- Meets all European standards for on and off-road vehicles (CE & E-Mark Certified)
- Size - 4"W x 2.5"D x 3."H
- Mounting – two .5"Lx.25"W slots and two .75"Lx.25W slots on 3.25" center
- Net Weight – 1 lb

FEATURES:

- Rugged glass filled nylon housing
- Steam Cleanable/Pressure Washable
- Low current, high efficiency dome speaker
- Can be used on positive and negative ground vehicles
- Compact size allows for horizontal or vertical mounting in protected areas

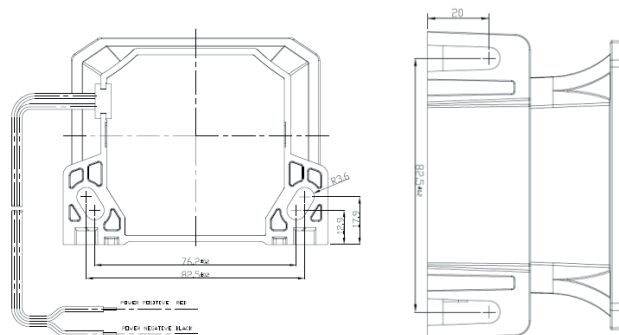



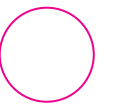
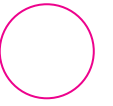



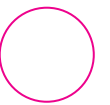





WIRING COLOR CODES







RECREATION VEHICLE 7 - POLE CONNECTORS

No.	Color	Circuits	Recommended Wire Gauge
1	White 	Ground Return	10 Ga
2	Blue 	Electric Brake	12 Ga
3	Green 	Tail, License and Running Lights	14 Ga
4	Black 	Battery Charge	10 Ga
5	Red 	Stop & Left Hand Turn Signal	14 Ga
6	Brown 	Stop & Right Hand Turn Signal	14 Ga
7	Yellow 	Auxiliary Circuit	14 Ga





HEAVY DUTY TRUCK 7 - POLE CONNECTORS

No.	Color	Circuits	Recommended Wire Gauge
1	White 	Ground Return	8 Ga
2	Black 	Clearance, Side Marker, and Identification Lamps	12 Ga
3	Yellow 	Left Turn & Hazard Signal	12 Ga
4	Red 	Stop Lamps & Anti-Lock Devices	10 Ga
5	Green 	Right Turn Signal & Hazard Signal	12 Ga
6	Brown 	Tail, Rear Clearance, Marker, and License Plate Lamps	12 Ga
7	Blue 	Auxiliary Circuit/ABS	10 Ga

UNIVERSAL 6 - POLE CONNECTORS

No.	Color	Circuits
1	White 	Ground Return
2	Brown 	Tail Lights
3	Yellow 	Left Turn
4	Red 	Stop
5	Green 	Right Turn
6	Blue 	Auxiliary Circuit

UNIVERSAL 4 - POLE CONNECTORS

No.	Color	Circuits
1	White 	Ground Return
2	Green 	Right Turn & Brake Lights
3	Yellow or Red  	Left Turn & Brake Lights
4	Brown 	Tail Lights

For POLLAK[®] products, contact:

Note: Check all circuits before operating vehicles

WIRE GAUGE SELECTION CHART

Note: This chart is based upon a 10% voltage drop. For 5% voltage drop, use double the measured wire length. When mechanical strength is a factor, use next larger wire gauge.

12-VOLT SYSTEM		Total length of Cable in Circuit from Battery to Most Distant Lamp										12-VOLT SYSTEM		Total length of Cable in Circuit from Battery to Most Distant Lamp									
AMPS (Appl.)	Candle Power	2.5 Ft. GA.	5 Ft. GA.	10 Ft. GA.	20 Ft. GA.	30 Ft. GA.	40 Ft. GA.	50 Ft. GA.	60 Ft. GA.	80 Ft. Ga.	100 Ft. Ga.	AMPS (Appl.)	Candle Power	2.5 Ft. GA.	5 Ft. GA.	10 Ft. GA.	20 Ft. GA.	30 Ft. GA.	40 Ft. GA.	50 Ft. GA.	60 Ft. GA.	80 Ft. Ga.	100 Ft. Ga.
1.0	6	20	20	20	20	20	20	20	20	20	18	12	100	20	20	18	16	14	12	12	10	10	8
1.5	10	20	20	20	20	20	20	20	20	20	18	15	120	20	20	18	14	12	12	10	10	8	8
2	16	20	20	20	20	20	20	20	18	18	16	18	140	20	20	16	14	12	10	10	8	8	8
3	24	20	20	20	20	20	20	18	18	16	14	20	160	20	18	16	12	12	10	10	8	8	6
4	30	20	20	20	20	18	16	16	16	14	12	22	180	20	18	16	12	10	10	8	8	8	6
5	40	20	20	20	18	18	16	14	14	12	12	24	200	20	18	16	12	10	10	8	8	6	6
6	50	20	20	20	18	16	16	14	14	12	12	36		20	16	14	10	8	8	8	6	6	4
7	60	20	20	20	18	16	14	14	12	12	10	50		18	16	12	10	8	6	6	4	4	2
8	70	20	20	20	16	16	14	12	12	10	10	100		14	12	10	6	4	4	2	2	1	0
10	80	20	20	18	16	14	12	12	12	10	10	150		14	10	8	4	2	2	1	0	00	000
11	90	20	20	18	16	14	12	12	10	10	8	200		12	8	6	4	2	1	0	00	000	0000

Open Space for your notes:

POLLAK® Numerical Part Number Index

PART #	PAGE#	PART #	PAGE#	PART #	PAGE#	PART #	PAGE#	PART #	PAGE#
CONNECTORS		CONNECTORS CON'T		BALL SWITCHES					
11-200.....	13	11-990.....	14	21-361.....	27	31-139.....	31	33-105.....	33
11-400.....	11	11-998.....	14	21-363.....	28	31-152.....	31	33-107.....	33
11-402.....	11	12-200.....	13	21-364.....	28	31-159.....	30	33-150.....	33
11-403.....	11	12-300.....	13	21-370.....	28	31-159-001.....	34	33-200.....	26
11-404.....	11	12-400.....	13	21-381.....	27	31-164.....	31		
11-405.....	13	12-401.....	13	21-400.....	28	31-166-001.....	34	TOGGLE/ROCKER SWITCHES	
11-408.....	11	12-402.....	13	21-434.....	27	31-173-102.....	34	33-300.....	21
11-409.....	11	12-405.....	13	21-435.....	27	31-173-104.....	34	33-302.....	20
11-410.....	11	12-403.....	13	21-437.....	27	31-178.....	30	33-400.....	24
11-500.....	11	12-404.....	13	21-443.....	28	31-180.....	30	33-402.....	24
11-501.....	11	12-410.....	17	21-444.....	28	31-190.....	30	33-403.....	24
11-502.....	11	12-411.....	17	21-448.....	27	31-191.....	31	34-111.....	22
11-600.....	10	12-412.....	13	21-456.....	27	31-192.....	31	34-212.....	19
11-602.....	10	12-413.....	13	21-458.....	27	31-196.....	30	34-213.....	19
11-603.....	10	12-414.....	13	21-465.....	28	31-223.....	31	34-215.....	19
11-604.....	10	12-415.....	13	21-467.....	28	31-228.....	30	34-216.....	19
11-605.....	10	12-417.....	13	21-478.....	28	31-229.....	31	34-218.....	19
11-606.....	10	12-418.....	13	21-481.....	27	31-231.....	31	34-219E.....	19
11-607.....	10	12-419.....	13	21-482.....	28	31-233.....	30	34-219E.....	19
11-608.....	10	12-421.....	13	21-487.....	27	31-242.....	30	34-220.....	19
11-609.....	10	12-422.....	13	21-487.....	27	31-243.....	31	34-222E.....	19
11-613.....	10	12-422.....	13	21-491.....	28	31-245.....	31	34-223E.....	19
11-614.....	10	12-423.....	13	21-492.....	28	31-249.....	31	34-225.....	19
11-616.....	10	12-424.....	13	21-493.....	28	31-249.....	31	34-226E.....	19
11-617.....	10	12-425.....	13	21-495.....	28	31-253.....	32	34-230.....	22
11-617.....	10	12-426.....	13	21-509.....	27	31-257.....	31	34-231.....	22
11-626.....	10	12-500.....	13	21-509.....	27	31-267.....	32	34-232.....	22
11-627.....	10	12-501.....	13	21-517.....	27	31-267.....	32	34-233.....	22
11-647E.....	10	12-600.....	13	21-532.....	28	31-273.....	31	34-234.....	22
11-700.....	6	12-601.....	13	21-538.....	28	31-280.....	31	34-235.....	22
11-702.....	6	12-610.....	17	21-541.....	26	21-282S.....	33	34-236.....	22
11-704.....	6	12-611.....	17	21-547.....	28	31-285.....	32	34-237.....	22
11-710.....	6	12-611.....	17	21-562.....	28	31-288.....	33	34-238.....	22
11-720.....	7	12-625.....	17	21-595.....	28	31-289.....	31	34-239.....	22
11-721.....	7	12-700.....	15	MOMENTARY SWITCHES		31-290.....	31	34-240.....	22
11-723.....	7	12-701U.....	15	24-359.....	25	31-292.....	30	34-241.....	22
11-724.....	7	12-702.....	15	24-360.....	25	31-292-801.....	30	34-255.....	22
11-729.....	7	12-703.....	15	24-362.....	25	31-292-802.....	30	34-258.....	22
11-730.....	7	12-704.....	15	24-363.....	25	31-292-803.....	30	34-259.....	22
11-732.....	9	12-705.....	15	24-372.....	25	31-292-804.....	30	34-260.....	22
11-733.....	9	12-706.....	15	24-372.....	25	31-292-805.....	30	34-301.....	21
11-735.....	9	12-707.....	15	24-373.....	25	31-292-806.....	30	34-305.....	21
11-736.....	9	12-709.....	15	24-390.....	25	31-297.....	32	34-306.....	21
11-737.....	9	12-710.....	15	24-391.....	25	31-302.....	32	34-307.....	21
11-739.....	9	12-711U.....	14,15	24-392.....	25	31-305.....	30	34-308.....	21
11-761.....	7	12-712.....	15	24-393.....	25	31-309.....	32	34-310.....	21
11-762.....	6	12-716.....	16	24-394.....	25	31-322.....	31	34-311.....	21
11-763.....	6	12-717.....	16	24-394.....	25	31-324.....	31	34-312.....	21
11-764.....	6	12-717.....	16	24-395.....	25	31-332.....	34,36	34-359.....	21,54
11-771.....	7	12-718.....	16	25-349.....	26	31-337.....	32	34-360.....	21
11-773.....	7	12-719.....	16	25-350.....	26	31-339.....	34	34-500.....	21
11-777.....	7	12-720.....	10	25-351.....	21,26	31-345.....	32	34-504.....	21
11-779.....	7	12-723.....	17	25-352.....	26	31-359.....	31	34-508.....	22
11-780.....	7	12-724.....	17	25-358.....	26	31-498-01.....	31	34-513.....	21
11-781.....	7	12-725.....	17	25-370.....	21,54	31-499.....	34	34-570.....	20
11-785.....	8	12-726.....	17	25-371.....	54	31-527.....	31,34	34-570Q.....	20
11-786.....	8	12-727.....	17	25-372.....	26	31-537.....	34	34-571.....	20
11-796.....	9	12-728.....	17	IGNITION SWITCHES		31-600.....	31	34-571C.....	22
11-797.....	8	12-729.....	16	31-103.....	30	31-600-103.....	34	34-571L.....	20
11-801.....	9	12-741.....	17	31-104.....	30	31-601.....	31	34-571LQ.....	20
11-802.....	9	12-742.....	17	31-105.....	30	31-602.....	33	34-571Q.....	20
11-833.....	8	12-743.....	16	31-106.....	30	31-603.....	33	34-572.....	20
11-850.....	12	12-744.....	16	31-109.....	30	31-604.....	33	34-572Q.....	20
11-851.....	12	12-750.....	17	31-110.....	30	31-607.....	30	34-573.....	20
11-852.....	12	12-751.....	17	31-111.....	30	31-608.....	30	34-573Q.....	20
11-853.....	12	12-752.....	17	31-112.....	31	31-609.....	32	34-574.....	20
11-893.....	14	12-777.....	17	31-114.....	31	31-610.....	30	34-574Q.....	20
11-896.....	16	12-800.....	12	31-117.....	33	33-104.....	33	34-575.....	20
11-898.....	14	12-801.....	12	31-119.....	31				
11-900.....	6	12-811.....	8	31-122.....	31				
11-902.....	6	12-812.....	8	31-124.....	30				
11-904.....	6	12-905.....	15	12-905.....	15				
11-910.....	6	12-906.....	15	12-906.....	15				
11-932.....	14,16	12-907.....	15	31-131.....	30				
11-933.....	14,16	CABLES		31-132.....	30,34				
		14-116.....	16						
		14-117.....	16						

POLLAK[®] Numerical Part Number Index

PART # PAGE# PART # PAGE# PART # PAGE# PART # PAGE#

TOGGLE/ROCKER SWITCHES CON'T

34-575Q.....20
 34-576.....20
 34-576Q.....20
 34-577.....20
 34-577LQ.....20
 24-577Q.....20
 34-578.....20
 34-578Q.....20
 34-579.....20
 34-579Q.....20
 34-580.....20
 34-580L.....20
 34-580LQ.....20
 34-580Q.....20
 34-581Q.....19
 34-586.....19
 34-586Q.....19
 34-588Q.....19
 34-591LQ.....20
 34-591Q.....20
 34-592.....52,54
 34-592Q.....20
 34-593Q.....20
 34-593LQ.....20
 34-596.....20
 34-653.....20

PUSH-PULL SWITCHES

35-300.....24
 35-306.....24
 35-316.....24
 35-319.....24
 35-320.....24
 35-330.....24
 35-331.....24
 35-333.....24
 35-334.....24
 35-335.....24

BACK-UP ALARMS

41-706.....56
 41-761.....56
 41-802.....56
 41-820.....58
 41-821.....58
 41-822.....58
 41-851.....57

FUEL SELECTOR VALVES

42-151.....53
 42-159.....52
 42-201.....52,53,54
 42-203.....52,54
 42-300.....52
 42-302.....52
 42-308.....52

MASTER DISCONNECT SWITCHES

51-303.....36
 51-308EP.....36
 51-311.....36
 51-902EP.....35
 51-904EP.....36
 51-927EP.....35
 51-915EP.....35
 51-916EP.....35

MISC. ELECTRICAL PRODUCTS

51-918EP.....36
 51-919EP.....36
 51-322.....36
 52-100.....48
 52-104.....39
 52-138.....49
 52-139.....49
 52-214.....48
 52-214Q.....48
 52-239.....45
 52-240.....45
 52-241.....45
 52-242.....45
 52-243.....45
 52-244.....48
 52-245.....48
 52-246.....48
 52-247.....48
 52-248.....48
 52-249.....45,48
 52-250.....39
 52-252.....39
 52-253.....39
 52-255.....49
 52-256.....49
 52-259.....48
 52-260.....39
 52-261.....39
 52-262.....37
 52-263.....37
 52-270.....48
 52-271.....48
 52-272.....48
 52-273.....48
 52-274.....48
 52-304-01.....38
 52-305-01.....38
 52-307-01.....38
 52-312-01.....38
 52-315.....38
 52-324-01.....38
 52-327.....38
 52-328.....38
 52-329.....38
 52-330.....38
 52-331.....38
 52-336.....38
 52-337.....38,50
 52-400.....49
 52-406.....48
 52-408.....48
 52-410.....48
 52-412.....48
 52-600.....26
 52-602.....49
 52-611.....26
 52-613.....26
 52-616.....39
 52-620.....26,39
 52-622.....26,39
 52-623.....26,39
 52-624.....26,39
 52-625.....39
 52-626.....39
 52-627.....39
 52-633.....39
 52-642.....24
 52-660.....49
 52-661.....49
 52-777.....49
 52-800.....34

CIRCUIT BREAKERS

54-110PL.....42
 54-115.....9
 54-120.....9,42
 54-120PL.....42
 54-125.....42
 54-125PL.....42
 54-130.....9,42
 54-130PL.....42
 54-135PL.....42
 54-140.....42
 54-150.....42
 54-150PL.....42
 54-215.....42
 54-215PL.....42
 54-220.....42
 54-220PL.....42
 54-225.....42
 54-230.....42
 54-230PL.....42
 54-240.....42,45
 54-240PL.....42
 54-250.....42
 54-250PL.....42
 54-311PL.....44
 54-321PL.....44
 54-331PL.....44
 54-510PL.....42
 54-515.....42
 54-515PL.....42
 54-520.....42
 54-520PL.....42
 54-525.....42
 54-530.....42
 54-530PL.....42
 54-540.....42
 54-540PL.....42
 54-550.....42
 54-550PL.....42
 54-597.....44
 54-616PL.....44
 54-630PL.....44
 54-631PL.....44
 54-640PL.....44

CIRCUIT BREAKERS CON'T

54-641PL.....44
 54-650PL.....44
 54-651PL.....44
 54-705.....43
 54-710.....43
 54-715.....43
 54-720.....43
 54-725.....43
 54-730.....43
 54-831PL.....42
 54-850PL.....45
 54-851PL.....45
 54-852PL.....45
 54-853PL.....45
 54-854PL.....45
 54-860PL.....45
 54-861PL.....45
 54-862PL.....45
 54-863PL.....45
 54-864PL.....45
 54-870PL.....45
 54-871PL.....45
 54-872PL.....45
 54-873PL.....45
 54-874PL.....45
 54-875PL.....45
 54-876PL.....45
 54-880PL.....45
 54-881PL.....45
 54-882PL.....45
 54-883PL.....45
 54-884PL.....45
 54-920.....43
 54-921.....43
 54-930.....43
 54-931.....43
 54-940.....43
 54-941.....43
 54-950.....44
 54-951.....44
 54-953.....44
 54-954.....44
 54-955.....44
 54-956.....44
 54-957.....44
 54-958.....44
 54-959.....44
 54-960.....44

Pollak®

by  SMP®

PollakAftermarket.com

3718 Northern Blvd., Long Island City, NY 11101

Pollak® offers many custom designed and produced products not shown in this catalog. Please contact us to discuss your custom switch needs with our representatives.



Distributed By